

0. COVER

ORIGINATOR: TAXUD/R4	ISSUE DATE:	VERSION: 1.00 – EN
TERMS OF REFERENCE INVITATION TO TENDER TAXUD/2013/AO-03 Intra muros consultancy services for European Union IT systems and applications in the customs, excise and taxation areas (TAXUD-TIMEA2)		

[Blank for duplex printing]

0.1.TABLE OF CONTENTS

0. COVER.....	1
0.1. TABLE OF CONTENTS.....	3
0.2. TABLE OF TABLES	5
0.3. TABLE OF FIGURES	6
0.4. ACRONYMS AND DEFINITIONS.....	7
0.5. REFERENCES	15
1. INTRODUCTION	16
2. SCOPE OF THIS INVITATION TO TENDER.....	18
2.1. SCOPE	18
3. BACKGROUND INFORMATION	19
3.1. PROGRAMMES.....	19
3.1.1. <i>The Customs 2013 programme.....</i>	<i>19</i>
3.1.2. <i>The Fiscalis 2013 programme.....</i>	<i>19</i>
3.1.3. <i>The Customs 2020 and Fiscalis 2020 programmes.....</i>	<i>19</i>
3.1.4. <i>Other.....</i>	<i>20</i>
3.2. IT SERVICES	20
4. IT BACKGROUND OF DG TAXUD	21
4.1. IT IN SUPPORT TO POLICY.....	21
4.2. IT SYSTEMS.....	21
4.3. DG TAXUD IT SERVICES	24
4.4. THE CCN/CSI NETWORK	26
4.5. RECENT ACHIEVEMENTS AND FUTURE DEVELOPMENTS	26
4.6. IT GOVERNANCE.....	28
4.7. THE IT ORGANISATION OF DG TAXUD.....	28
4.8. IT CONTRACTORS OF DG TAXUD	32
4.8.1. <i>DG TAXUD IT Value Chain.....</i>	<i>32</i>
4.8.2. <i>As-is DG TAXUD Contract Organisation overview (July 2013).....</i>	<i>34</i>
4.8.3. <i>Target DG TAXUD Organisation overview (2013-2014)</i>	<i>35</i>
4.9. SERVICE LEVEL MANAGEMENT	36
4.10. STRATEGY FOR QUALITY MANAGEMENT	37
4.11. TEMPO METHODOLOGY	38
5. CONSULTANT PROFILES - REQUIREMENTS.....	41
5.1. AREA OF ACTIVITY	41
5.2. PROFILES.....	41
5.2.1. <i>Project manager (Profile P1).....</i>	<i>42</i>
5.2.2. <i>Service manager (Profile P2).....</i>	<i>43</i>
5.2.3. <i>Project support expert (Profile P3).....</i>	<i>44</i>
5.2.4. <i>BPM analyst (Profile P4).....</i>	<i>45</i>
5.2.5. <i>IT analyst (Profile P5).....</i>	<i>46</i>
5.2.6. <i>Enterprise architect (Profile P6).....</i>	<i>47</i>
5.2.7. <i>Application architect (Profile P7).....</i>	<i>49</i>
5.2.8. <i>Infrastructure architect (Profile P8)</i>	<i>51</i>
5.2.9. <i>Operations expert (Profile P9).....</i>	<i>53</i>
5.2.10. <i>Application expert (Profile P10).....</i>	<i>54</i>
5.2.11. <i>Security expert (Profile P11)</i>	<i>55</i>
6. ADMINISTRATIVE PROCEDURES	57
6.1. ORDERING PROCESS	57
6.2. TIME AND MEANS ORDERS	57
6.3. INTERFACES, ROLES AND RESPONSIBILITIES	59
6.4. SERVICE MEETINGS	60
6.5. SECURITY CLEARANCE.....	60
6.6. EXCHANGE OF DOCUMENTS	60

6.7.	ROADMAP FOR TIME & MEANS PROJECTS	61
6.8.	REPORTING	65
6.9.	REPORTING TEMPLATES	66
7.	DELIVERY	71
7.1.	PLACE OF DELIVERY AND MISSIONS	71
7.2.	WORKING HOURS	71
7.3.	LANGUAGES	72
7.4.	TRAINING	72
8.	OTHER REQUIREMENTS	73
8.1.	AVAILABILITY	73
8.2.	PROCEDURES DOCUMENTATION	73
8.3.	CONFIDENTIALITY	73
8.4.	DELIVERABLES	73
8.5.	OWNERSHIP	74
9.	PORTFOLIO OF SYSTEMS, APPLICATIONS, AND IT SERVICES FOR CUSTOMS (UPDATED 3/2013).....	75
9.1.	THE BUSINESS ENVIRONMENT	75
9.1.1.	<i>Policy Units</i>	75
9.1.2.	<i>National Administrations (NAS)</i>	75
9.1.3.	<i>Management Committees</i>	75
9.1.4.	<i>Working Groups / Parties and Economic Operators</i>	76
9.1.5.	<i>Interactions With NAs, Business Units and Other Parties In the european commission.</i> ..	76
9.2.	ARCHITECTURE AND STRATEGY BACKGROUND.....	76
9.2.1.	<i>IT Strategy & IT Master Plan</i>	76
9.2.2.	<i>IT Customs Architecture</i>	78
9.2.3.	<i>EU Customs IT Collaboration</i>	79
9.3.	CUSTOMS BUSINESS ANALYSIS AND MODELLING BACKGROUND	79
9.4.	THE PORTFOLIO OF CUSTOMS IT SYSTEMS AND APPLICATIONS	81
9.4.1.	<i>Portfolio overview</i>	81
9.4.2.	<i>NCTS</i>	83
9.4.3.	<i>ECS</i>	85
9.4.4.	<i>ICS</i>	87
9.4.5.	<i>CS/RD</i>	87
9.4.6.	<i>CS/MIS</i>	88
9.4.7.	<i>STTA</i>	88
9.4.8.	<i>TTA</i>	88
9.4.9.	<i>SPEED-ECN</i>	89
9.4.10.	<i>SSTA</i>	89
9.4.11.	<i>ART2</i>	90
9.4.12.	<i>CN</i>	90
9.4.13.	<i>SUSP</i>	91
9.4.14.	<i>CRMS</i>	92
9.4.15.	<i>COPIS</i>	93
9.4.16.	<i>SMS</i>	93
9.4.17.	<i>DDS2</i>	94
9.4.18.	<i>EOS</i>	97
9.4.19.	<i>EOS-MRA</i>	98
9.4.20.	<i>RSS</i>	99
9.4.21.	<i>EBT13</i>	101
9.4.22.	<i>ECICS2</i>	102
9.4.23.	<i>ISPP</i>	103
9.4.24.	<i>Quota2</i>	103
9.4.25.	<i>SURV2</i>	104
9.4.26.	<i>TARIC3</i>	105
9.4.27.	<i>TATAF</i>	106
9.4.28.	<i>SPEED2</i>	106
9.5.	FUTURE PERSPECTIVES.....	107

9.5.1.	<i>Perspective 2020</i>	107
9.5.2.	<i>SOA Implementation</i>	108
9.5.3.	<i>Customs Decisions</i>	109
9.6.	CUSTOMS CENTRAL APPLICATIONS – ARCHITECTURAL ASPECTS.....	109
9.6.1.	<i>Overview of the TARIFF Application TECHNICAL ARCHITECTURE Framework (TATAF)</i>	109
9.6.2.	<i>DDS2 Framework</i>	111
9.7.	IT STATISTICS – BUSINESS OPERATIONS SUPPORT	112
9.7.1.	<i>Incident management</i>	113
9.7.2.	<i>Change management</i>	117
9.7.3.	<i>Release management</i>	119
10.	PORTFOLIO OF SYSTEMS, APPLICATIONS, AND IT SERVICES FOR TAXATION AND EXCISE (UPDATED 10/2012)	120
10.1.	DG TAXUD BUSINESS ENVIRONMENT.....	120
10.1.1.	<i>IT in support to EU Tax policy</i>	120
10.1.2.	<i>Recent achievements and Future developments</i>	121
10.1.3.	<i>Other actors in Taxation and Excise</i>	123
10.2.	THE PORTFOLIO OF TAXATION AND EXCISE IT SYSTEMS AND APPLICATIONS	126
10.2.1.	<i>Overview</i>	126
10.2.2.	<i>VAT Related systems</i>	131
10.2.3.	<i>Recovery</i>	144
10.2.4.	<i>Direct Tax related Systems</i>	146
10.2.5.	<i>Other Tax Related Systems and Applications</i>	148
10.2.6.	<i>Support applications common to VAT, Recovery and Direct Tax</i>	150
10.2.7.	<i>Application supporting information exchange between MS and DG TAXUD</i>	151
10.2.8.	<i>Excise TES and applications</i>	152
10.3.	EVOLUTION OF TAXATION AND EXCISE TES AND NEW PROJECTS.....	158
10.3.1.	<i>Evolution of Taxation TES and applications</i>	158
10.3.2.	<i>Evolution of Excise Systems</i>	161
10.3.3.	<i>EU Enlargement</i>	161
10.3.4.	<i>New projects</i>	162
10.4.	OPERATIONAL INFORMATION.....	164
10.4.1.	<i>Taxation systems</i>	164
10.4.2.	<i>Excise TES and applications</i>	168
10.4.3.	<i>Evolution of operation by the Horizon 2020</i>	172
11.	CCN NETWORK	175
11.1.	OVERVIEW OF THE CCN NETWORK	175
11.2.	OBJECTIVES OF THE CCN/CSI MIDDLEWARE.....	177
11.3.	SERVICES OFFERED TO THE APPLICATIONS OF THE NAS	178
11.4.	SECURITY.....	179
11.5.	ADMINISTRATION	180
11.6.	CCN/CSI SUBSYSTEMS	181
11.7.	THE FUTURE OF THE CCN NETWORK	183

0.2. TABLE OF TABLES

Table 1:	Portfolio of customs IT systems and applications.....	83
Table 2:	NCTS - Key indicators per year.....	85
Table 3:	ECS - Key indicators per year.....	86
Table 4:	ICS - Messages and errors per year.....	87
Table 5:	NCTS-RU - Messages and movements volumes per year since start in 2009	89
Table 6:	DDS2 operational figures for 01/09/2011- 31/08/2012 period	97
Table 7:	RSS count.....	101
Table 8:	Specification and software incidents opened	113
Table 9:	Production/conformance incidents closed.....	114
Table 10:	RfIs opened	115

Table 11: RfIs closed	116
Table 12: Change requests opened.....	117
Table 13: Change requests closed	118
Table 14: Number of full releases and patches/hotfixes delivered.....	119
Table 15: Taxation systems portfolio overview	129
Table 16: Excise systems portfolio overview.....	130
Table 17: VAT exchange of forms.....	138
Table 18: Recovery exchange of forms.....	145
Table 19: Direct Tax exchange of forms.....	148
Table 20: VIES operation.....	165
Table 21: VIES-on-the-Web operation	165
Table 22: Exchange of forms operation	166
Table 23: VAT on e-Services operation.....	166
Table 24: Taxation on Savings operation.....	166
Table 25: Taxation Service Calls metrics - Calls per CI.....	167
Table 26: Taxation Service Calls metrics - Calls per Priority.....	167
Table 27: Taxation Service Calls metrics - Calls per Category	168
Table 28: SEED deliveries	168
Table 29: SEED-on-Europa web page hits	168
Table 30: TA deliveries.....	169
Table 31: TA rapid releases	169
Table 32: CS/MISE releases	169
Table 33: EMCS Service calls metrics.....	172

0.3. TABLE OF FIGURES

Figure 1: Trans-European System Development Lifecycle	23
Figure 2: IT organisation in DG TAXUD.....	30
Figure 3: DG TAXUD IT Value Chain.....	33
Figure 4: Support contracts' target situation at DG TAXUD	35
Figure 5: NCTS volume of movements per year	85
Figure 6: ECS evolution of operations.....	86
Figure 7: SPEED2.....	107
Figure 8: Overview of the TARIFF Application Technical Architecture	110
Figure 9: Overview of the DDS2 Architecture Framework.....	111
Figure 10: DDS2 Network Diagram	112
Figure 11: Overview Initial VIES Phase V/Unicode Application	134
Figure 12: Acceptance testing infrastructure.....	141
Figure 13: EMCS Applications Cartography	154
Figure 14: EMCS Test Application architecture.....	156
Figure 15: MVS Requests sent vs. replies received	170
Figure 16: EMCS Service calls per Month	171
Figure 17: Taxation Traffic evolution horizon 2020 – Number of Messages – Min-1SS refers to the VAT Mini One Stop Shop	172
Figure 18: Taxation Traffic evolution horizon 2020 – Volume in Gigabytes.....	173
Figure 19: EMCS traffic evolution by 2020 – Number of messages	173
Figure 20: EMCS traffic evolution by 2020 – Volume in Gigabytes	174
Figure 21: CCN/CSI topology overview.....	175
Figure 22: CCN/CSI synchronous service	178
Figure 23: CCN/CSI asynchronous service	178
Figure 24: CCN/CSI HTTP traffic	179
Figure 25: CCN/CSI Functional Subsystems.....	181

0.4.ACRONYMS AND DEFINITIONS

In this document, the Directorate-General Taxation and Customs Union of the European Commission, which is the contracting authority, will be further referred to as “the Commission” or “DG TAXUD”.

Acronym	Definition
AAD	Administrative Accompanying Document
ACDT	Administrative Cooperation Direct Taxation
ACL	Access Control List
AD	Application Assembler, Deployer and Administrator
AEO	Authorised Economic Operator
AEOI	Automated Exchange of Information
AFA	Application For Action
AFIS	Anti-Fraud Information System (OLAF)
AGRI	Directorate-General for Agriculture and Rural Development
AIS	Automated Information System
ANSI	American National Standards Institute
API	Application Programming Interface
ARIS	Architecture of Integrated Information Systems
ART2	Activity Reporting Tool 2
ATIS	Anti-Fraud Transit Information System
B2B	Business to Business
B2C	Business to Consumer
BPEL	Business Process Execution Language
BPM	Business Process Modelling
BPMN	Business Process Modelling Notation
BTI	Binding Tariff Information
CACT	Committee for Administrative Cooperation in Taxation
CC	Customs Code
CCIP	Customs Code Implementing Provision
CCN	Common Communication Network
CDEA	Centrally Developed Excise Application
CEA	Central Excise Application
CI	Configuration Item
CIRCA	Communication and Information Resource Centre Administrator

Acronym	Definition
CIRCABC	Communication and Information Resource Centre Administrator
CIS	Customs Information Systems
CISSP	Certified Information Systems Security Professional
CLO	Central Liason Officer
CMDB	Configuration Management Database
CMMI	Capability Maturity Model Integration
CN	Combined Nomenclature
Cobit	Control Objectives for Information and Related Technology
COL	Customs Liason Officer
COM	Commission
COPIIS	System for Protection of Intellectual Property Rights (COunterfeiting and PIracy)
COTS	Commercial Off-The-Shelf software
CQP	Contract Quality Plan
CRMS	Community Risk Management System
CS	Continuous Services
CSI	Common Systems Interface
CSI_API	Common Systems Interface Application Programming Interface
CSSLP	Certified Secure Software Lifecycle Professional (International Information Systems Security Certification Consortium)
CSV	Comma Separated Value
CT	Conformance Testing
CTP	Conformance Test Protocol
CUSTDEV2	Development contractor for customs systems 2
CV	Curriculum Vitae
CWCP	Customs Warehousing Collaboration Pilot project
DB	Data Base
DBMS	Database Management System
DC	Data Centre
DDNEA	Design Document for National Excise Applications
DDS	Data Dissemination System
DDSSPEED	Data Dissemination System
DEV	Developer/Tester
DG	Directorate General (within the Commission)
DIGIT	Directorate-General for Informatics
DMZ	De Militarised Zone

Acronym	Definition
DML	Definitive Media Library
EAFRD	European Agricultural Fund for Rural Development
EAGF	European Agricultural Guarantee Fund
EBTI	European Binding Tariff Information
EC	European Commission
ECAS	European Commission Authentication Service
eCFA	Electronic Forms Central Application
ECG	Electronic Customs Group
ECICS2	European Customs Inventory of Chemical Substances
ECN	EDI CSI Node
ECS	Export Control System
eCustoms	Electronic Customs
ECWP	EMCS Computerisation Working Party
EDIFACT	EDI for Administration Commerce and Transport
eFCA	Electronic Forms Central Application
eFDT	Electronic Forms for Direct Taxation
eFORM	Electronic Form
EFTA	European Free Trade Association
EIS	secure, integrated, interoperable and accessible customs computerised systems (also referred to as EIS)
EJB	Enterprise Java Bean
EMAP	Transit Movements Electronic Map
EMCS	Excise Movement and Control System
ENI	European Vessel Identification
ENS	Entry Summary Declaration
EOL	Excise Office List
EORI	Economic Operator Registration and Identification
EOS	Economic Operators System
EPP	Export Control Pilot Project
ESB	Enterprise Service Bus
EU	European Union
EUROFISC	Network for the swift exchange of targeted information between Member States
FAT	Factory Acceptance Testing
FATCA	US Foreign Account Tax Compliance Act
FESS	Functional Excise System Specification

Acronym	Definition
FISCO	FIScal COmpliance
FITS	Fiscalis Information Technology Services
FITSDEV2	Development contractor for Fiscalis systems (Replacing FITSDEV)
FQP	Framework Quality Plan
FTP	File Transfer Protocol
FTT	Financial Transaction Tax
FYROM	the former Yugoslav Republic of Macedonia
GAS	Generic Application Services
GB	Gigabyte
GNC	Globally Networked Customs
GQI	General Quality Indicator
GTT	Generic test Tool
HR	Croatia
HTML	HyperText Markup Language
HTTP	HyperText Transport Protocol
IAB	Inter Application Bus
IAM	Identify & Access Management
IATA	International Air Transport Association
ICAO	International Civil Aviation Organization
ICS	Import Control System
ICT	Information & Communications Technology
ID	Individual Delivery
IDA	Interchange of Data between Administrations
ILIADe	Intra Laboratories Inventory Of Determinations
IMAP4	Internet Message Access Protocol 4
IMO	International Maritime Organization
INF	Infringement
INN	International Non-proprietary Names for Pharmaceutical Substances
IP	Internet Protocol (Version 4, Version 6)
IPR	Inward Processing Relief
IPSec	Internet Protocol Security
IS	Information System
ISD	Infrastructure & Service Delivery
ISMS	Information Systems Security Management
ISO	International Organisation for Standardisation
ISPP	Information System for Processing Procedures

Acronym	Definition
IT	Information Technology
ITIL	Information Technology Infrastructure Library
ITSC	Information Technology Steering Committee
ITSM	IT Service Management
ITT	Invitation To Tender
IUPAC	International Union of Pure and Applied Chemistry
J2EE	Java 2 Platform, Enterprise Edition
JCSI_API	Java Common Systems Interface Application Programming Interface
JDBC	Java Database Connectivity
JMS	Java Messaging Services
JSP	Java Server Pages
KPI	Key Performance Indicator
LAN	Local Area Network
LCMS	Local CCN Mail Server
LCT	Local Conformance Testing
LISO	Local Information Security Officer
LPAR	Logical Partitioning
MARE	Directorate-General for Maritime Affairs and Fisheries
MASP	Multi-Annual Strategic Plan
MCC	Modernized Customs Code (renamed to UCC)
MCC	Minimal Custom Core
MDM	Master Data Management
MIS	Management Information System
MISE	Management Information System for Excise
MOM	Message Oriented Middleware
MOSS	Mini One Stop Shop
MQ	Message Queue
MR	Movement Reference
MRA	Mutual Recognition Arrangement /Agreement
MRN	Movement Reference Number
MS	Member States
MSA	Member State Administration
MSCON	Member State of Consumption
MSID	Member State of Identification
MVS	Movement Verification System
NA	National Administration(s)

Acronym	Definition
NCTS	New Computerised Transit System
NDEA	Nationally Developed Excise Applications
NETP	Non Established Taxable Person
NTA	National Transit Applications
OECD	Organisation for Economic Co-operation and Development
OJ	Official Journal
OLA	Operational Level Agreement
OLAF	Office de Lutte Anti-fraude / European Anti-Fraud Office
OMG	Object Management Group
OOPEC	Office for Official Publications of the European Communities
OS	Operating System
OSB	Oracle Service Bus
PC	Personal Computer
PDF	Portable Document Format
POP3	Post Office Protocol 3
PQP	Project Quality Plan
PS	Project Support
PSAT (preSAT)	Pre Site Acceptance Test
QA	Quality Assurance
QC	Quality Control/Quality Controller
QMS	Quality Management System
QoS	Quality of Service
Quota	Tariff Quotas management systems
RCT	Remote Conformance Test
RD	Reference Data
RDBMS	Relational Database Management System
RfI	Request for Information
RIF	Risk Information Form System
RSS	Regular Shipping Services
RUP	Rational Unified Process
SAAD	Simplified Administrative Accompanying Document
SAFT	Standard Audit File for Tax
SAT	Site Acceptance Test
SCAC	Standing Committee for Administrative Co-operation
SCIT	Standing Committee responsible for Information Technology

Acronym	Definition
SD	Service Desk
SDR	Surveillance Data Records
SEED	System for Exchange of Excise Data
SLA	Service Level Agreement
SLM	Service Level Management
SMS	Specimen Management System
SMT	Service Management Tool
SMTP	Simple Mail Transfer Protocol
SNMP	Simple Network Management Protocol
SOA	Service Oriented Architecture
SOAP	Simple Object Access Protocol
SPEED	Single Portal for Entry or Exit of Data
SPI_API	System Programming Interface _ Application Programming Interface
SQI	Specific Quality Indicator
SQL	Structured Query Language
SSL	Secure Socket Layer
SSTA	Standard SPEED Test Application
SSTS	Self-Service Testing System
STTA	Standard Transit Test Application
SunOS	Sun Operating System
SURV2	Surveillance
SUSP	Suspension
T&M	Time and Means
TA	Technical Annex
TARIC3	The Integrated Tariff of the EU
TATAF	Tariff Application Technical Architecture Framework
TAXREF	Taxation Reform system
TAXUD	Directorate-General for Taxation and Customs Union
TC	Technical Support
TCP	Transmission Control Protocol
TEDB	Taxes in Europe Database
TEMPO	TAXUD Electronic Management of Project On-line
TES	Trans-European System
TESS	Technical Excise System Specification
TIN	Taxes Identification Number
TIR	Transports Internationaux Routiers (International Road Transport)

Acronym	Definition
TM	Time & Means
TOGAF	The Open Group Architecture Framework
ToR	Terms of Reference
ToS	Taxation on Savings system
ToW	Tax Identification Number on the web
TQS	Tariff Quota and Surveillance system
TRACE	Treaty Relief and Compliance Enhancement
TRADE	The Directorate General for Trade
TSS	Taxation Statistics Sysetm
TTA	Transit Test Application
UCC	Union Customs Code
UIPE	Uniform Instrument Permitting Enforcement
UK	United Kingdom
ULD	Unit Load Device
UM	User Management
UML	Unified Modeling Language
UN	United Nations
UNF	Uniform Notification form
URL	Uniform Resource Locator
US'	United States
USA	United States of America
VAT	Value Added Tax
VIES	VAT Information Exchange System
VMS	VIES Monitoring System
VoeS	VAT on e-Services
VoW	VIES on the Web
VSS	VIES Statistics System
VTA	VIES Test Application
VTL	Virtual Tape Library
WAN	Wide Area Network
WAR	Weekly Activity Report
WG	Working Group
WLS	WebLogic Server
WS	Web Services
WSDL	Web Service Definition Language

Acronym	Definition
XML	eXtensible Markup Language
XSLT	eXtensible Stylesheet Language Transformations

0.5. REFERENCES

Throughout this ITT package references are made to:

TEMPO: Taxud Electronic Management of Project Online (TEMPO) is a Quality Management System (QMS) that has been established in the DG Taxud IT Unit environment to support the business goals and objectives of DG Taxud. It is the DG Taxud methodology to ensure the consistent and efficient management, set-up, development, operation and support of projects and service management.

The tendering parties are invited to access TEMPO through the following URL:

<https://circabc.europa.eu/faces/jsp/extension/wai/navigation/container.jsp>

User name: **tempo.guest**
 Password: **Welcome700Taxud**

TEMPO+ group appears then.

Detailed login information is found in Annex XIII to the Tendering Specifications.

The latest Release of TEMPO is to be used by the TIMEA2 tenderer. The list of TEMPO documents referred to in this document is only added in order to make the reading easier. They are neither exhaustive nor legally binding; they are only provided as additional information.

Refer to section 4.11 for more information on TEMPO.

1. INTRODUCTION

DG TAXUD manages a set of operational activities in the areas of customs, excise and taxation. These activities target the needs of users in the Commission services, as well as those located in the national administrations of the Member States, and citizens in general. Most of the IT systems managed by DG TAXUD are trans-European systems spanning all Member States (e.g. Transit and Excise control systems, VAT network). They have an extremely large user population in the national administrations, in the trader community and in society as a whole. To support these trans-European systems, common functional and technical system specifications are defined, a closed and secure trans-European communication network (named CCN/CSI), as well as several applications and databases have been developed and are operated under the management of DG TAXUD. New trans-European systems are also being developed.

DG TAXUD IT steers, manages and quality controls the deliveries of the external suppliers and delivers itself its services to its customers (policy units, Member States) with an internal team made of statutory staff supported by intra muros experts. The intra muros experts provide on request their technical expertise to the TAXUD staff in order for the latter to fulfil their "public service" obligations. There is a strict segregation of responsibilities and access to information between the TAXUD staff and the intra muros experts. Intra muros experts are only allowed to deal with technical issues at the exclusion of any financial, procurement and contractual aspects.

All the trans-European information systems have a legal basis and they receive budgetary support from two programmes, Customs 2013 and Fiscalis 2013 and their respective successors (Customs 2020 and Fiscalis 2020).

To promote consistent and efficient development of projects and applications, DG TAXUD has created, develops and maintains the TEMPO methodology for projects and services. Large parts of the IT development and operations activities are outsourced to external service providers. DG TAXUD wants to ensure that there is continuous quality and maturity improvement, that the different projects are well managed, that deliverables are supplied on time and within budget, that services are delivered according to expectation, and that the cooperation between DG TAXUD and its service providers is optimal, within the framework of its TEMPO methodology.

The ToR of this ITT provides:

- a description of the scope of this ITT;
- background information;
- requirements for consultant profiles;
- information on administrative procedures, delivery and other requirements;
- portfolio of systems, applications, IT services and CCN network.

DG TAXUD invites the reader to take note of all the content of TEMPO as the project life cycle follows the internal project management methodology of DG Taxation and

Customs Union, as well as constituting a general information base on the activities of the DG for Taxation and Customs Union.

2. SCOPE OF THIS INVITATION TO TENDER

2.1.SCOPE

This Invitation to Tender is for one Framework Contract of a duration of three (3) years, with options for maximum two (2) extensions of one (1) year each, to cover the provision of intra muros consultancy services in business, technical and project related activities for current and future IT projects and operations mandated by the Customs 2013 programme, the Fiscalis 2013 programme, their respective successors and others in the scope of DG TAXUD activities.

This Framework Contract will be referred to in the following text as the “*TIMEA2 contract*” and the contractor as the “*TIMEA2 contractor*”.

In order to fulfil its objectives, DG TAXUD requires consultancy services to provide advice and expertise both on the business and technical project levels. In parallel, administrative assistance is needed to support the various projects in an efficient way.

An average of 50 person-years consultancy is required per annum over the duration of the framework contract, to support the personnel of DG TAXUD. Please note that the above-mentioned number of person-years/annum is indicative and may be subject to some variation over the duration of the framework contract.

The contractor will have to provide the services of consultants experienced in project and service management, project support, BPM and IT analysis, enterprise, application and infrastructure architecture, operations, applications and security to assist the project leaders in their mission, as well as to provide advice and best practice in the fields of Taxation, Excise and Customs IT applications.

The services will be delivered intra muros (on site).

3. BACKGROUND INFORMATION

3.1. PROGRAMMES

The programmes furnish the legal basis, the budget and the governance framework for the IT services, the provision of which falls under the responsibility of DG TAXUD. Major IT services may require additional dedicated legal bases to foster their policy legitimacy and set up the implementation and operation obligations of all the national administrations and the Commission.

3.1.1. THE CUSTOMS 2013 PROGRAMME

In the area of customs, the role of DG TAXUD is to maintain and defend the Customs Union and to ensure the uniform application of the Customs Code (CC) which it administers and controls. The strategy is to ensure that the national customs administrations apply the law as if they were a single customs administration. DG TAXUD has a general policy of using IT systems for all flows of information and control mechanisms necessary for the uniform administration of the Customs Union. The Customs 2013 programme [Decision 624/2007/EC of the European Parliament and of the Council], and its successors, provide a legal and financial basis for the operation, maintenance, development and improvement of electronic information exchange systems between national administrations. Customs 2013 is an EU cooperation programme providing national customs administrations with the possibility to create and exchange information and expertise. It allows developing and operating major trans-European IT systems in partnership and establishing various human networks by bringing together national officials from across Europe.

3.1.2. THE FISCALIS 2013 PROGRAMME

In the area of taxation, DG TAXUD ensures the effective, uniform and efficient application of European Union law, which is essential for the functioning of the internal market. The Fiscalis 2013 programme [Decision 1482/2007/EC of the European Parliament and of the Council] and its successors, provides a legal and financial basis for the operation, maintenance and improvement of existing communication and information-exchange systems and the development and introduction of new information-exchange systems. Fiscalis 2013 is an EU cooperation programme enabling national tax administrations to create and exchange information and expertise. It allows developing and operating major trans-European IT systems in partnership, as well as establishing various person to person networks by bringing together national officials from across Europe.

3.1.3. THE CUSTOMS 2020 AND FISCALIS 2020 PROGRAMMES

The Commission is setting up Customs 2020 and Fiscalis 2020 as successor programmes for Customs 2013, on the one hand, and for Fiscalis 2013 on the other. These programmes provide the budgetary and co-ordination framework for implementing and operating most of the IT instruments required to support the customs and taxation policies. The adoption process for Customs 2020 and Fiscalis 2020 programmes is on-going and should be completed before the end of the year 2013.

3.1.4. OTHER

DG TAXUD also requires IT services to support its policies which fall outside the scope of the established programmes. These IT services are financed by the European Union budget allocated to the legal instrument underpinning the “customer” policy and are subject to the governance defined in the policy legal basis. However, the size and number of the IT services falling into this category are expected to remain limited compared to the IT services spearheaded by the programmes.

3.2.IT SERVICES

The portfolio of IT services provided by DG TAXUD (composed of a set of systems and applications) is described in chapters 9, 10 and 11 of this document.

4. IT BACKGROUND OF DG TAXUD

4.1.IT in SUPPORT to policy

DG TAXUD coordinates and manages a set of operational activities relying on IT systems in support of the European Union (EU) policies for customs, taxation and excise duties. Actually, this comprises direct and indirect taxation, tariff strategy, eCustoms, the future Union Customs Code, risk management, safety and security, the fight against counterfeited goods, as well as international policy objectives.

TAXUD's IT systems are a unique instrument to sustain the continuity of operation of a broad range of customs and taxation procedures within the EU.

The main objectives are:

- To support the uniform management of the Customs Union and to maintain the fluidity of the flow of goods at the border of the EU through the availability of customs trans-European systems, such as the New Computerised Transit System, the Export Control System and the Import Control System. Any unavailability of these systems would have an immediate and highly visible adverse impact on the economic activity of the EU, such as lorry queues at the borders and ports, loss of containers, distortion in the application of legislation, increased risk of fraud and loss in revenue collection etc.
 - To contribute to the fight against fraud:
 - o In the area of customs: TAXUD's IT systems support the sharing of risks profile amongst Member States and feed the European Anti-fraud Office (OLAF) with information on sensitive consignments;
 - o In the area of taxation: IT systems also allow for a rapid exchange of secure information and thus for the efficient fight against different types of tax fraud. This is the case in the areas of:
 - VAT, through the VAT Information Exchange System;
 - savings through the Taxation on Savings system;
 - administrative co-operation and mutual assistance;or to better control movement of excise goods across the EU.
- To facilitate the handling of tax and customs procedures for citizens and economic operators by enabling the refund of VAT from a Member State (in which an economic operator is not established) and through the publication of the most relevant information (including customs tariff, balances of tariff quotas, VAT number identification, etc.), contained in its IT systems on the Commission's Europa website.

Some traders have integrated the availability of the information in their daily processes. Therefore, they rely heavily on this service. The success of these services is constantly increasing, with the number of queries made by the traders exceeding 120 million requests in 2011.

4.2.IT SYSTEMS

Most of the IT systems of DG TAXUD are trans-European systems spanning all Member States (MS) of the EU. The users are the National Administrations, the EU

traders' and the Commission Services. Other IT systems include systems to manage reference data, test and monitoring applications, and dissemination applications to the wide public (e.g. via the Europa web site).

A Trans-European System (TES) performs specific business functions in Customs or Taxation as defined in or in support of Union policies. A trans-European system is a **collection of collaborating systems (orchestrated and choreographed) with responsibilities distributed across the National Administrations and the Commission.** It includes processes, applications, services and infrastructure.

All the IT systems under the responsibility of the Commission have a legal basis¹ and receive budgetary support from EU programmes, currently Customs 2013 and Fiscalis 2013 for which they represent a significant part of the expenditure. The Customs 2013 and Fiscalis 2013 programmes will be replaced by the Customs 2020/Fiscalis 2020 programmes, which are proposed for the period 2014 – 2020.

The development of an IT system constitutes a major project to be run over several years.

The bidders are invited to read the full description of the trans-European systems lifecycle under TEMPO.

An extract from this documentation is provided here below to introduce the notion of the lifecycle, the respective phases of the Trans-European System development project and the deliverables.

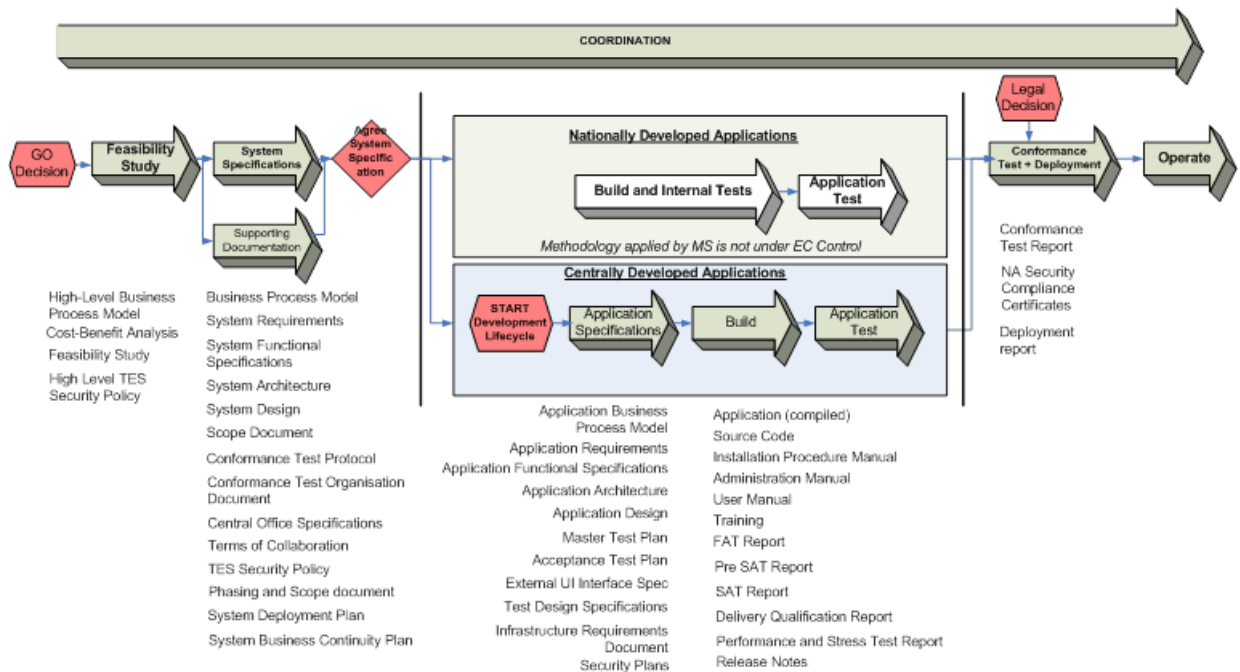

1 For example, in 2008 important legal acts for IT systems were the so-called “VAT package”, the future Modernized Customs Code (renamed Union Customs Code since then) and the eCustoms decision on a paperless environment for customs and trade.

Figure 1: Trans-European System Development Lifecycle

As examples of some IT systems, we can mention:

- **In the field of taxation: the VIES network** enables the tax administrations to verify trader's VAT identification numbers and statements of their intra-EU turnover, *the VAT on e-Services system* provides for the management of the VAT revenues in connection with services provided on the internet by non-EU traders, *the VAT refund system* enables traders to obtain the refund of VAT from a Member State in which they are not established, *the Taxation on savings system* enables Member States to exchange information on interest payments by paying agents established in their territories to individuals resident in other Member States;
- **In the field of Customs: the New Computerised Transit System (NCTS)** which provides a fully computerised customs regime for goods which enter into the Common Transit, *the Quota system* enables to publish the tariff quotas and tariff ceiling to the trader community, *the Transit system* enables the customs offices to automatically track and control the movements of goods in transit through the EU, *the Export Control System* provides full control on the conclusion of export operations in particular when different Member States are involved, *the Import Control System* is devoted to the import operations, *the Surveillance System* complements the other customs systems and contributes to the fight against fraud by enabling the surveillance of the movement of goods inside and outside the EU;
- **In the field of Excise: Excise Movement and Control System (EMCS)** allows for the monitoring and control in real-time of the movement of excise goods (alcohol, tobacco and energy products).

DG TAXUD also makes available, through the Commission's Europa website, a wide range of information and services to the citizens and to the traders in order to enable them to consult measures relating to tariff, commercial and agricultural legislation, tariff quotas, to query authorized economic operators, to consult the list of transit customs offices, validate VAT numbers, to consult the main taxes in force in the EU Member States or to query excise numbers.

On 01/01/2009, an electronic connection was launched with Russia to allow for secure data exchange of TIR movement data, in order to address lorry congestion at the EU-Russia border (currently 3,500 movements supported daily). Currently, a new version of SPEED (namely SPEED2) is under development, and is expected to be in production in 2013.

All these activities rely on a secure and reliable interoperability middleware between the Member States and the Commission: the Common Communication Network (CCN) that TAXUD has developed and operated for more than 14 years in the European Union and which allows the exchange of a massive amount of messages and information.

In particular, in the context of EU enlargement, connecting the candidate countries to the network is one of the first IT activities to be started well before the target enlargement date.

The CCN, given its central role, is an important component of the whole IT architecture to ensure the security, availability and continuity of the service. It is

managed by the Commission and has evolved over the years in the biggest network linking the Commission and Member States, in terms of number of application data exchanges and probably among the largest administrative networks worldwide. In coming years, this network will move towards an interoperability-enabler interconnecting more services.

4.3.DG TAXUD IT SERVICES

The customs & taxation policies have required, for more than fifteen (15) years, the implementation of IT trans-European services:

- either in a distributed way to allow the exchange of information between national administrations (VIES, NCTS, EMCS, ..), or
- in a "hub" and "spoke" way when the Commission has to fulfil an obligation concerning the exchange of information (mostly for customs applications).

In parallel, the emergence of the Web and the irresistible push towards eGovernment lead DG TAXUD to offer an increasing number of services to the citizen via its presence on EUROPA². These services provide the citizen with a view of the critical business information which is exchanged between the Commission and the national administrations

(http://ec.europa.eu/taxation_customs/common/databases/index_en.htm).

Considering the “multi-agency” customer base of customs, DG TAXUD has an increasing number of automated interactions with other Directorates General of the Commission. The VAT register managed by DG TAXUD is also likely to attract attention from other Directorates General in search of systems of trader registration.

DG TAXUD also provides IT services to serve its own internal business needs, so far mainly in the area of customs.

This “user” base of DG TAXUD is likely to expand in volume in the years to come.

It is crucially important to understand that, in order to serve its user base, DG TAXUD manages IT services which rely:

- on **Centrally Developed Applications** operated by the Commission, and
- on a set of **trans-European systems** made up of geographically spread, but tightly interoperating & collaborating, applications operated by the national administrations and the Commission.³

While most of the publicly available methodology and best practice frameworks assume that a single organisation is responsible for its ICT services from start to end, DG TAXUD is for most of its IT assignment going well beyond this paradigm as it has

² The Commission's official web portal (<http://europa.eu>).

³ For the sake of simplification, the other Directorates General can be considered as being part of the trans-European systems managed by DG TAXUD as they are interconnected via a common network (CCN/CSI).

to manage, coordinate and facilitate trans-European IT services, of which most of the Configuration Items (CI) are set up, deployed, operated and managed by the national administrations. DG TAXUD has a dual responsibility in IT service management:

- at central application level:
 - deploy and operate all applications required to meet its policy and operational obligations, and operate a Service Desk to support these EU applications. There are applications to serve:
 - the national administrations in several ways: business applications, statistics & monitoring applications, test applications, web servers, call management,
 - the citizen via Europa,
 - the other Directorates General;
 - in some cases, develop and support applications that national administrations may want to operate nationally to ease the burden of meeting their operational obligation(s) for a specific trans-European system.
- at trans-European system level:
 - produce the common system specifications, coordinate the deployment of trans-European services as required by the policies to be implemented, perform the Conformance Testing (CT) of each national application before granting it the right to join operations, monitor the Quality of Services (QoS) of the national applications, elaborate business and technical statistics, facilitate the resolution of incidents between national administrations, run continuous improvement programmes, as well as operate a central Service Desk (SD) to support these systems,
 - operate and maintain the Common Communications Network (CCN) which offers a point of presence in each NA to allow all constitutive applications of a system to interoperate via a secure network.

The Central Applications (deployed and operated by DG TAXUD, or third parties on its behalf) serve in general:

- the national applications via CCN,
- officials in the national administrations in most cases via CCN and in some cases via the Internet,
- citizens via the point of presence of the customs & taxation applications on Europa,
- other Directorates General and services of the Commission or inter-institutional bodies such as DG AGRI, Eurostat, DG MARE, DG TRADE, OOPEC, and probably others in the future,
- officials of DG TAXUD.

Additional information on the trans-European systems of DG TAXUD is available from TEMPO.

4.4.THE CCN/CSI NETWORK

The exchange of information between the national administrations and between the national administrations and the Commission is supported by a closed and secure Trans-European network managed by DG TAXUD, CCN/CSI, which provides:

- synchronous services based on the CSI API;
- asynchronous services based on the CSI API;
- HTTP(S) services;
- E-mail services (smtp, pop3, IMAP, webmail);
- security services;
- limited presentation services;
- statistical and monitoring services.

The CCN network is made up of

1. a set of CCN entry points or DMZ (between the national networks and a secure closed CCN IP network) located in the premises of the Taxation and Customs Administrations of the Member States and some third countries, operated by the Commission and containing:
 - CCN gateways (known as access points) offering HTTPS and CSI services;
 - SMTP servers, hosted centrally offering secure e-mail services,.
2. a Trans-European IP service interconnecting the CCN DMZ in a closed user group through an encryption box. All information exchanged in operation through CCN/CSI is encrypted while all test and administration exchanges are in clear.
3. the CSI (Common System Interface) is the "driver" (API) which allows a national computer environment to access the CCN. The CSI is available in all IT environments in use in the Taxation and Customs national administrations connected to CCN.

The operational ITSM2 contractor provides support services for the connected parties: remote CCN/CSI gateway configuration & administration via the IP service, training, help desk, technical support, registration agency for all CCN/CSI related configuration parameters.

The Commission operates (via its ITSM2 contractor) a set of CCN gateways that its contractors use to access the CCN network remotely, via the Telecom Centre of the Commission. The Commission provides the necessary CCN gateways, training and support at no cost for the contractors.

For more information please refer to chapter 11 in this document.

4.5.RECENT ACHIEVEMENTS AND FUTURE DEVELOPMENTS

The capacity demonstrated over the last two decades in the creation of successful IT systems supporting the integration of customs and fiscal administrations in the EU has positioned IT at the heart of the European construction in the areas of customs and taxation.

In particular, for Customs, the eCustoms Decision underlined the central role of DG TAXUD in the creation of systems supporting the Customs Union and generated the

need for a number of new trans-European systems successfully deployed over 2009-2011. The Union Customs Code and its implementing provisions added a new challenge for IT since it requires reassessing the whole of the customs procedures and underlying IT systems in order to meet the diversity of expectations from the different stakeholders. Specification work with the Member States has started with the definition of the business process models, the development of an IT Master Plan and of a reference enterprise architecture of customs systems.

The perspectives for developing new IT systems under Taxation spanned over 2009 for VAT refund systems and over 2010 for the systems related to Recovery and Direct Taxation. In the longer term (2015), the one-stop-shop IT system will greatly simplify the tax declarations for e-commerce, telecommunication and broadcasting activities throughout the EU.

The years 2009-2011 were unique in terms of the high number of IT systems deployed into operations. A strong commitment and collaboration between the Member States and the Commission was required to respect deadlines:

- A batch of Customs systems were deployed by 01/07/2009: the system for economic operators, the upgrade of the transit system for security, anti-fraud information, enquiry and recovery procedure, and the upgrade of the export control system.
- A batch of Taxation systems were deployed by 01/01/2010 (several improvements of the quality of data under the VAT network, the VAT package, and the upgrade of the Europa services on VAT). The exchange of electronic forms for the recovery of claims, for mutual assistance in the field of direct taxation, and for Council Regulation (EC) No 1798/2003⁴ and Commission Regulation (EC) No 1925/2004⁵ in VAT was deployed as well. Also, common projects were launched concerning e.g. exchange of eForms, self-testing services, statistics and exchange of administrative information. In 2011 a new version of the Taxes in Europe Database (TEDBv2) was deployed as well as a new release of Recovery e-Forms for Council Directive 2010/24/EU⁶.
- The new Import Control System (ICS), the upgrade of the integrated EU tariff management system followed in 2010, together with the entry into operation of the Excise Movement Control System (EMCS), which improves the functioning of the Internal Market and helps fighting fraud.
- Also a new version of CCN was put in production, as well as a new service management tool (Synergia).

DG TAXUD may anticipate an increase of the volume of IT activities and IT operations for the years to come. This is due to the future deployment of additional customs IT systems as a result of the eCustoms Decision and the Union Customs Code, the operation of the EMCS in its full capacity (due to its expansion into Phase 3), of the VAT package, and possible additional systems for exchange of data between the EU and third countries such as Japan, China and US, and the Eastern neighbourhood.

⁴ OJ L 264/1, 15.10.2003

⁵ OJ L 331/13, 05.11.2004

⁶ OJ L84/1, 31.03.2010

In order to cope with the new IT systems and the expected growth of the traffic, the private Common Communication Network (CCN) will need to be upgraded as well. This concerns not only its capacity but also its security and its overall architecture. Additional information on future developments is available in chapters 9, 10 and 11.

4.6.IT GOVERNANCE

Experience suggests that the time to develop and deliver a trans-European IT system ranges from 2 to 8 years according to the complexity and the level of implication of the Member States. This demands to manage each Trans-European IT project under strict governance, using a proven project management methodology.

The management of Trans-European IT projects involves different levels of governance, involving the Commission and the National Administrations.

- DG TAXUD is assisted by Comitology committees such as the Customs 2013, Fiscalis 2013 committees, and the Standing Committee on Administrative Cooperation. These groups are each supported by a sub-committee dedicated to IT matters. Each IT sub-committee meets several times a year under TAXUD's chairmanship with the participation of heads of IT from National Administrations.
- Technical Experts' groups with the National Administrations to deal with technical related project matters which meet with a frequency from monthly to quarterly according to the pace of development. Each TES and IT Services from the Commission are overseen by such a working group (ex: Electronic Customs Group, Union Customs Code Group, etc.).

DG TAXUD also needs to ensure that any decision on IT matters is taken in full understanding of the context, challenges, impact and associated risks. This is why DG TAXUD applies internally strong IT governance. All the IT systems are managed under the supervision of an IT Steering Committee, chaired by the Director General and composed of the board of Directors and the head of the financial and human resource unit. The IT Steering Committee meets regularly (quarterly on average) and takes decisions on IT working plans, priorities and resource allocation upon proposal from the IT units.

4.7.THE IT ORGANISATION OF DG TAXUD

The Information Technology Steering Committee (ITSC) of DG TAXUD acts to ensure high-level authorisation for IT projects in line with the principles of good management and financial governance, under the overall supervision of the IT governance bodies of the Commission.

The Stakeholders for DG TAXUD information systems are the Commission, National Administrations, traders or the public in general.

The Information Technology Units (R4 and R5) are responsible for administering the computerisation activities of DG TAXUD in line with the policies of the DG. This includes the provision of business-critical operational services and central information systems necessary for the support of the National Administrations and Commission services.

The mission of the Information Technology Units is to:

- Develop and operate secure Information Systems (IS) and transmission services appropriate to beneficiaries in DG TAXUD, other Commission departments and Member State administrations;
- Maintain and develop a coherent Information Systems Architecture consistent with the Commission standards policy, allowing interoperability of administrations in the EU and partner countries for the benefit of the Customs and Tax policies;
- Provide and support efficient office automation facilities for approximately 550 staff of the DG TAXUD.

Units R4 and R5 are sub-divided into sectors as follows:

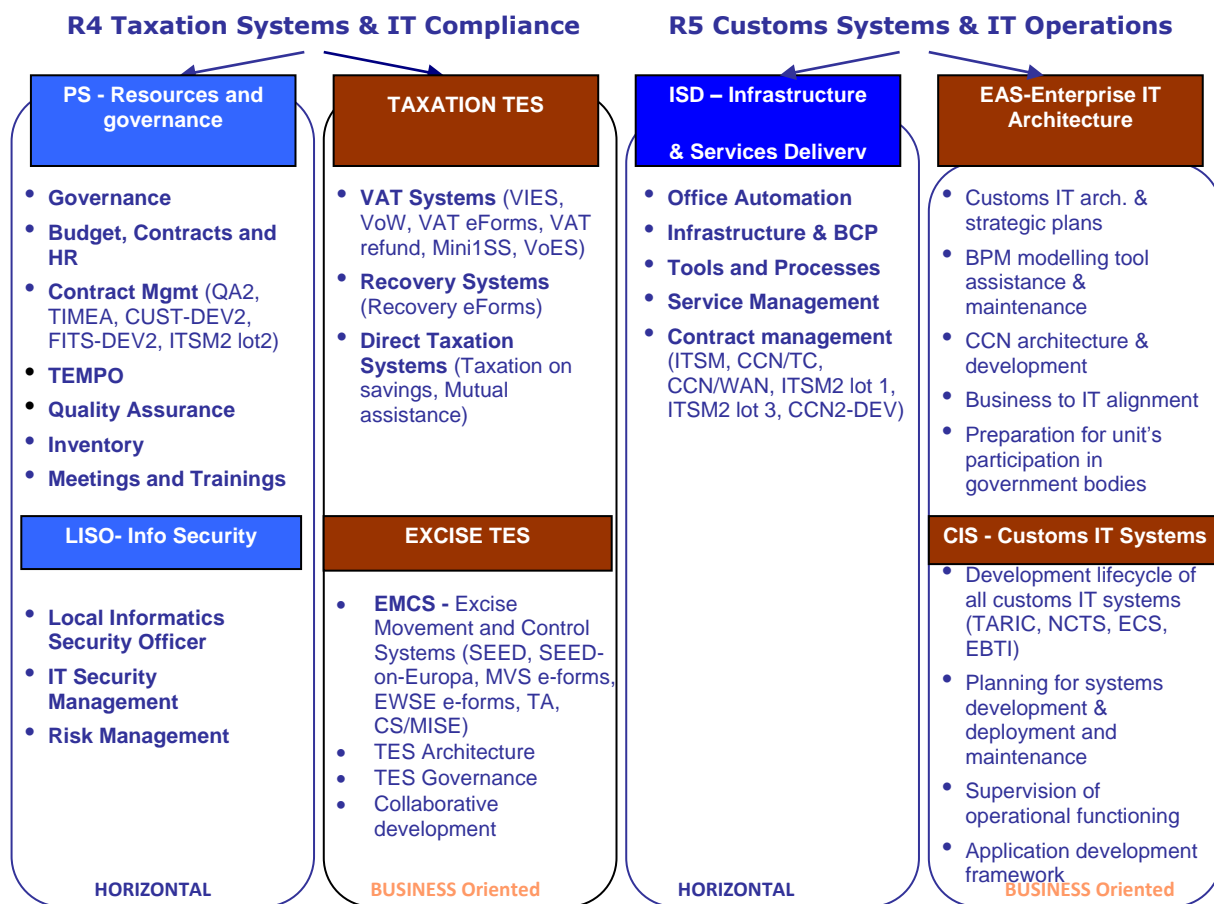

Figure 2: IT organisation in DG TAXUD

The **Unit R4** is divided into four sectors:

- **Resources and governance sector (R4/PS)**: is a “horizontal” sector involved with governance, budget, contracts and project management, and human resources. R4/PS provides services to all the other sectors of IT units R4 and R5. R4/PS manages the QA2 and TIMEA framework contracts, the development contracts (FITS-DEV2 and CUST-DEV2), and the ITSM2 Lot2 contract. R4/PS will manage also the TIMEA2, FITS-DEV3, CUST-DEV3 and QA3 framework contracts;
- **Excise Trans-European Systems sector (R4/EMCS)**: defines, maintains and evolves, in close cooperation with the Member States and on the basis of the EU legislation in place, the IT systems related to monitoring and controlling in real-time the movement of excise goods (alcohol, tobacco and energy products) for which duties still have to be paid. These systems are designed to simplify the administrative procedures for the traders involved in intra-EU movements of excise goods, while securing the fiscal revenue of the Member States. The sector also coordinates with the Member States to ensure the constant level of quality and correct functioning of these trans-European systems while in their operational phase. It is responsible for Taxation

& Excise TES Architecture and governance and for exploring the potential of collaborative development amongst the Member States;

- **Taxation Trans-European Systems sector (R4/TAX):** defines and creates EU-wide IT systems aiming at supporting the fight against fraud or simplifying the VAT compliance obligations, in close cooperation with the Member States. In the field of VAT the two main systems are VIES and VAT Refund. Part of the functionality of VIES is also used by the general public via the VIES-on-the-Web application. The sector has also developed standardised eForms to smoothen and fasten the administrative cooperation in the field of VAT, Recovery of Claims and mutual assistance for Direct Taxation. The sector has developed and maintains the Taxation on Savings system and the Taxes in Europe database;
- **Local Informatics Security Officer (LISO):** defines the DG TAXUD-specific Information Security Policy compliant with the European Commission Security Policy, oversees the development of security plans approved by DG TAXUD and monitors its implementation, develops information security awareness and training programmes, maintains an inventory of information systems, with a description of security needs, advises and reports on information systems security matters.

The **Unit R5** is divided into three sectors:

- **Infrastructure and Service Delivery (R5/ISD):** The sector is responsible for:
 - Providing office automation services (supply the office automation equipment, user support, helpdesk, management of IT logistics including acquisition, move and decommissioning).
 - Managing the infrastructure used by the Information Systems in support of the Customs and Tax policies, the DG TAXUD specific administrative processes.
 - Assuring continuity of operation of the IT function in case of disaster.
 - Operating the infrastructure allowing interoperability of administrations in the EU and partner countries for the benefit of the Customs and Tax policies (CCN contracts).
 - Managing the IT Operations (ITSM and ITSM2 contract) and network (CCN-WAN2 contract).
 - Designing and implementing the IT operation processes in DG TAXUD and all its suppliers.
- **Customs IT Systems (R5/CIS):** The sector is responsible for:
 - The system development lifecycle of all customs IT systems.
 - The maintenance of the operational planning for systems development and deployment.
 - The coordination of the implementation and maintenance of all customs IT systems in EU in collaboration with internal and external stakeholders.
 - The supervision of their operational functioning and the production of related statistics, dashboards, etc.
 - The system development lifecycle methodology for all customs IT systems.
 - The application development framework of all customs applications.
 - The maintenance of a repository of all artefacts of customs IT systems.
- **Enterprise IT Architecture and Strategy (R5/EAS):** The sector is responsible for:
 - The overall customs IT architecture and IT strategic plan.

- Providing assistance to customs business units for the correct use of the BPM modelling tool.
- Maintaining in the BPM modelling tool, in close cooperation with the customs units and CIS, a coherent view of the enterprise architecture, including its business data, business processes, business rules and technical IT plan.
- Providing advice to customs policy units for the optimal use of IT in reaching their policy objectives; to assure this duty, the section shall represent the unit in coordination groups created either internally or with the participation with MS in view of policy coordination and development.
- The technical studies, architecture and development of the CCN platform.
- The overall coherence of IT architecture of DG TAXUD, which operationally is implemented by the sections ISD and CIS.
- Assuring the secretariat of DG TAXUD's architecture board and through this body promoting business to IT alignment.
- Preparing the unit's participation in governance bodies, such as the ECG IT and legal, the IT steering committee, the High-level group for the UCC, etc.

In addition to the above, other DG TAXUD Units (e.g. **Unit A3**, in the Customs area, in charge of **UCC and BPM functional structure**) may to a limited extent use the services provided by these framework contract to support them in their assignment related to the programme management and business modeling.

4.8.IT CONTRACTORS OF DG TAXUD

4.8.1. DG TAXUD IT VALUE CHAIN

DG TAXUD relies on the Commission's DG for Informatics (DIGIT) for hosting part of the IT systems. In parallel, DG TAXUD **outsources the bulk of its IT activities to external service providers**, which are contracted through public procurement procedures in compliance with the Financial Regulation. The products and services supplied are all subject to a systematic quality control and testing as part of the acceptance procedures.

Currently, units **R4** and **R5** rely on several **external contractors** to perform their duties (refer to Figure 5 below for a graphical representation of the current contracts):

- Two development contractors (CUST-DEV2 for Customs, FITS-DEV2 for Taxation);
- One IT service management contract (ITSM2) with the following 3 lots:
 - Lot 1 for IT service management including CCN/CSI operations;
 - Lot 2 for trans-European systems management;
 - Lot 3 for operations integration and control;
- Two providers for building infrastructure (Data Centre Building Facilities);
- One common network provider (CCN/WAN2);
- One quality assurance/control contractor (QA2);
- Several consulting contractors to perform strategic studies and analyses.

The IT value chain of DG TAXUD is depicted below:

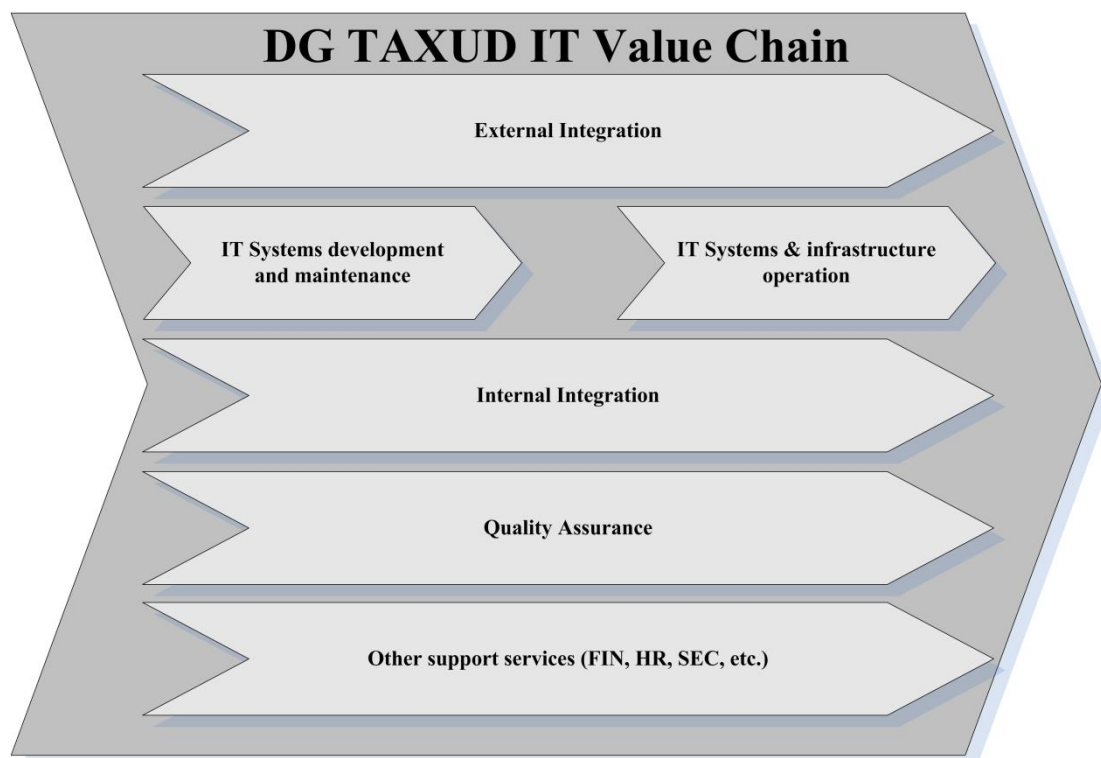

Figure 3: DG TAXUD IT Value Chain

External Integration is defined as the set of activities that are needed to integrate DG TAXUD's IT systems with those of the National Administrations (NAs) to deliver the expected business solutions. These comprise planning, scope definition, systems definition, and specification; follow up of NA activities, synchronization, enterprise architecture town plan, and others.

IT systems development and maintenance is one of the two main production activities of the IT units of DG TAXUD, it includes the multitude of development and maintenance activities for all Customs, Taxation, Excise systems as well as for CCN.

IT systems & Infrastructure operation is the second main production activity of the IT units of DG TAXUD, providing:

- The operations of all applications;
- A stable, documented, managed and secure ICT infrastructure;
- The setup and maintenance of harmonised processes and service management tools.

Internal integration is the set of activities that **TAXUD/R4 and R5** have to do internally to streamline and harmonise its architecture and services delivery. Much of this process is supported by TEMPO, internal governance arrangements, planning, reporting etc.

Quality Assurance and other support services (FIN, HR, SEC, etc.) are activities, processes that are shared activities between **TAXUD/R4** and **TAXUD/R5** and performed by the sector **TAXUD/R4/PS** and **TAXUD/R4/LISO**. QA is quality assurance and quality control of the IT services and deliverables supplied to

DG TAXUD by all its suppliers including conducting regular security and quality audits of them. Other support services concern financial aspects, human resources and secretariat.

4.8.2. AS-IS DG TAXUD CONTRACT ORGANISATION OVERVIEW (JULY 2013)

Development services are delivered by the CCN/TC, CUST-DEV2, FITS-DEV2 and ITSM2 contracts, the latter being restricted to support "Service Management related tools" and facilities necessary for the IT service management and related activities.

Operations rely on ITSM2, CCN/WAN2 contracts, the Data Centre (DC) Building Facilities and the Data Centre service of DIGIT.

ITSM2 Lot 1 provides IT service management, covering applications management, operations, hardware infrastructure and building infrastructure for both CCN and central applications; Lot 1 integrates IT systems and infrastructure operation, merging the previously separated CCN/TC operation and ITSM operations. The contract includes development and maintenance of its own "Service Management related tools" of which some are also used by other contractors (referred to as Synergia).

ITSM2 Lot 2 provides trans-European systems management. This lot provides support services for the coordination of implementation of trans-European systems in Member States for excise, taxation, and customs business threads.

ITSM2 Lot 3 provides Operations integration and control. This lot aims at providing advice for IT architecture, service management, service control, service improvement, change management and benchmarking.

CUST-DEV2 is a development and maintenance contract, which consolidates all customs-related development. The CUST-DEV2 contractor provides specification, development, maintenance and support services for all customs IT systems.

The FITS-DEV2 contractor provides specification, development and maintenance services for the taxation and excise systems and applications.

The CCN/TC contractor provides CCN/CSI application development and maintenance.

DC Building Facilities is the contract that provides the locations for the two Tier IV level Data Centres in Luxembourg that are used by DG TAXUD. All infrastructure hosted by ITSM and CCN/TC is in the process of being regrouped in these Data Centres, and will be operated by the ITSM2 Lot 1 contractor.

The CCN/WAN2 contractor provides the private secured IP network services of CCN including their maintenance.

DIGIT is the IT General Directorate of the Commission. DIGIT has responsibility for the Commission's Data Centre (DIGIT/DC) which hosts part of the DG TAXUD information systems.

The QA2 contractor is responsible for TEMPO maintenance quality assurance and quality control of the IT services and deliverables provided by the others IT contractors of DG TAXUD.

4.8.3. TARGET DG TAXUD ORGANISATION OVERVIEW (2013-2014)

A contractual renewal phase is in progress. In order to respond to the service challenges, it is considered necessary:

- To renovate CCN so as to modernise the existing facilities and create the new facilities necessary for the support of the existing political and operational objectives (**CCN2-DEV**). The CCN2-DEV framework contract shall provide essentially 3rd level support, maintenance services and development services for the existing CCN/CSI and future CCN2 Platform Infrastructure.
- To ensure continuity of the development contracts and plan the current CUST-DEV2 and FITS-DEV2 framework contracts will be replaced by the **FITS-DEV3** and **CUST-DEV3** framework contracts.
- To ensure the continuity of the TEMPO maintenance quality assurance and quality control of the IT services and deliverables provided by the other IT contractors of DG TAXUD the current QA2 framework contract will be replaced by the **QA3** framework contract.

The target organisation to be reached during 2013-2014 represents the current vision of DG TAXUD, without prejudice to further evolution as the need may arise.

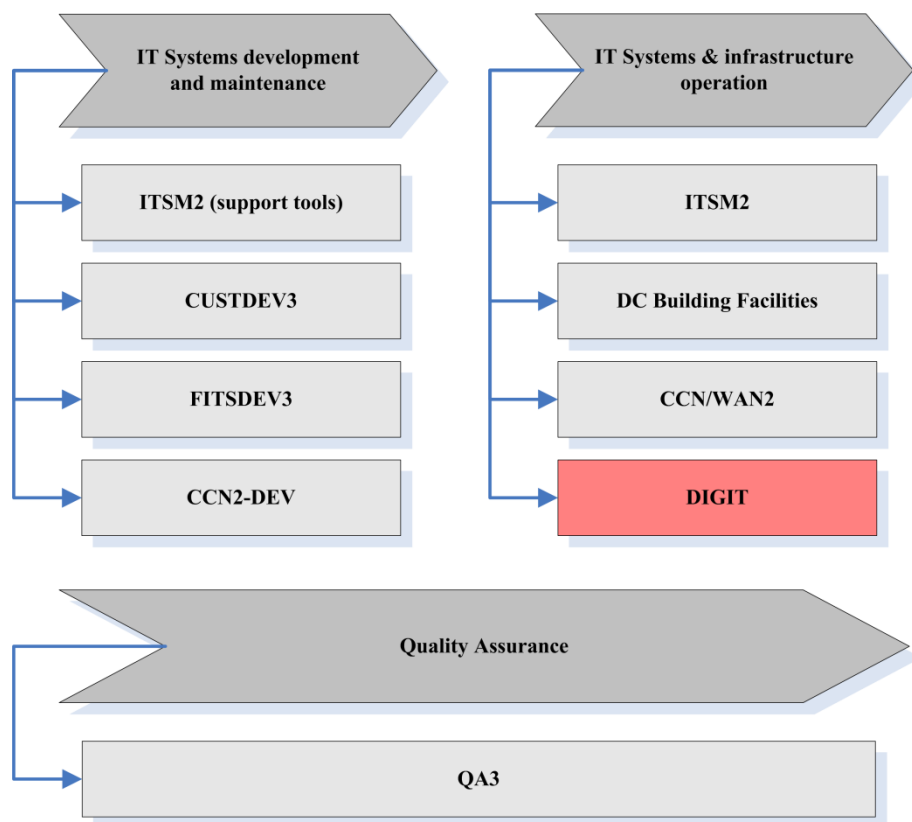

Figure 4: Support contracts' target situation at DG TAXUD

With regards the other layers of the IT value chain:

- **External integration** is supported by the ITSM2 Lot 2 contractor
- **Internal integration** is supported by the ITSM2 Lot 3 contractor.

4.9.SERVICE LEVEL MANAGEMENT

Units R4 and R5 of DG TAXUD are a **major IT service integrator** and depend extensively on its supplier base to provide all of its IT services according to the QoS expected by its customer and user base. Service Level Management is based on the following types of agreement:

The **Service Level Agreement**⁷ (SLA) is between DG TAXUD and the recipients of its services. It defines the minimum level of service expected by the recipients. It provides a mutual understanding of service level expectations and their measurement methods. This level of service addresses the activities provided by DG TAXUD to users of trans-European systems and applications of the business and ITSM threads. These users are currently identified as:

- The NAs;
- The users within the Commission, including also the other Directorates General;
- The citizens, via Europa;

The **Operational Level Agreements**⁸ (OLA) are set between the Commission and its 3rd party IT providers, for example with DIGIT/DC. An OLA defines the minimum operational levels that the 3rd party commits to deliver to the DG TAXUD.

The contractors support DG TAXUD in meeting its SLA obligations. The **contractual OLA** defines the Operational Level Agreement between DG TAXUD and a contractor relying on the definition and application of Specific Quality Indicators (SQIs).

The **Terms of Collaboration** define the mutual obligations of the NAs and DG TAXUD around the Common Domain. They can be considered as being both a multi-lateral SLA and OLA binding NAs and DG TAXUD around the Common Domain for each of the customer/user communities within each business and ITSM thread. The Terms of Collaboration are made up of:

- Common specifications of service catalogues, SLA, OLA;
- Common capacity/continuity/availability/security plans;
- Common specifications of ITSM processes (and supporting tools).

⁷ A Service Level Agreement (SLA) is by definition an agreement between the Commission IT department and the recipients of its services

⁸ An Operational Level Agreement (OLA) is by definition an agreement between the Commission IT department and the 3rd party suppliers of IT services.

4.10. STRATEGY FOR QUALITY MANAGEMENT

"**Quality management** is a method for ensuring that all the activities necessary to design, develop and implement a product or service are effective and efficient with respect to the system and its performance."⁹ In the context of DG TAXUD/R4 and R5 activities, quality management also includes activities related to the IT service management, once a product/service is operational.

Quality management is composed of two complementary sub-layers:

- The Quality Assurance (QA) sub-layer which defines the quality framework in which the project takes place;
- The Quality Control (QC) sub-layer performs the verification and validation of the quality of the deliverables produced by the contractors during the project within the quality framework defined by the QA sub-layer.

In order to produce deliverables of acceptable quality (documents, software, services, etc.) it is necessary to implement both quality sub-layers. The QA must be followed and reflected by the QC in order to be effective. The QC is almost impossible without the QA defining the QC scope and objectives but also the means to reach them. This implies that the QA and QC functions are mutually dependent.

Quality Assurance is described in TEMPO. Additional specific elements may be defined in the Quality Plans (PQP, FQP and CQP).

Specific Quality Indicators and the Global Quality Indicator (SQI & GQI) are the quality measurements used to evaluate the quality of the work packages delivered by the contractors. A complete description of the SQI/GQI process is found in TEMPO: "Service Level Agreement guide". This complete description covers not only services, but also development and testing quality indicators.

The actual SQIs are defined in the specific contract and related contractual OLA in place with the contractor and the calculation formula used for the normalisation of each SQI and the calculation of the GQI is specified in the technical annex of their contract.

In addition to the contractual quality indicators contractors may propose in their FQP and CQP a set of compliant metrics and associated thresholds.

Upon request from DG TAXUD, a quality and/or security audit of a contractor may be performed by the QA contractor. Such audits are performed in the context of the applicable framework contract, specific contract and quality plans. All contractors are subject to the same audit process. This process is summarised in the TEMPO audit fact sheet.

Quality Control is described in TEMPO. Additional specific elements may be defined in the Quality Plans (PQP, FQP and CQP).

⁹ Definition from Wikipedia, the free encyclopedia

The QC of developed software implies the successful performance of testing activities. This results in the production of test reports (FAT, SAT, reports). The QC of the document deliverables implies a formalised review cycle where the content of the deliverable is verified.

DG TAXUD has put into place a QA contractor who helps with the monitoring and the assurance that the projects conform to the quality principles defined and applied in the pertinent SLA/OLA and quality plans, on the basis of the TEMPO methodology. The QA contractor performs dedicated QA, QC or other quality oriented tasks.

The QA/QC activities are divided between the parties involved in Quality Management namely: DG TAXUD and the contractors.

All contractors are responsible for:

- QA activities:
 - Production of FQP and CQPs related to their contracts, taking into account the common rules for quality assurance described in the applicable PQP(s);
 - Set-up of the quality environment: including the set-up of quality organisation, definition of the quality approach (performance, measurement, verification);
 - Production of regular Quality Reports;
 - Usage of and compliance with the TEMPO Quality Methodology and all other standards mentioned in the contractual, quality and procedural documents (e.g. ITIL).
- QC activities:
 - Internal QC of deliverables, QC of internal organisation, use of internal audits, etc.
 - Maintenance of Quality records.

In addition to the responsibilities listed above for all contractors, the QA contractor is involved in:

- QA activities:
 - Production of the PQPs (one PQP per main business thread, i.e. Customs, Taxation, Excise);
 - Maintenance of the TEMPO Quality Methodology (Updates, trainings and the long-term strategy);
 - Audits (at least once a year) of the other contractors.
- QC activities:
 - QC of deliverables of other contractors;
 - Organisation of review cycles and participation in review cycles with NAs;
 - QC of SLM processes of other contractors;
 - QC of Tests: FAT, pre-SAT, SAT, qualifications and CT.

4.11. TEMPO METHODOLOGY

DG TAXUD wants to ensure that the different projects are well managed with deliverables on time and within budget and high-level Quality Assurance and Quality

Control, and that cooperation between DG TAXUD and its service providers is optimal. To do so, DG TAXUD has created, develops and maintains the **TAXUD Electronic Management of Project Online** (TEMPO) quality management system. This methodology is fully part of the technical specifications.

The **TEMPO** documentation is hosted on Europa web site (CIRCABC pages) and is available for members of the TEMPO Interest Group. Account registration can be requested via a dedicated mailbox. A specific account has been set-up for the tenderers to access the documentation. See section 0.5 “References” for the details of this account.

The tenderers are invited in particular to read the following TEMPO documentation:

- General documentation:
 - Introduction to TEMPO
 - Project Management reference manual
 - Quality Management reference manual and Quality Policy
 - Information Security reference manual and Information Security Policy
 - Specific Contract management reference manual and Deliverables acceptance reference manual, and procedures
- Trans-European systems:
 - Trans-European Systems (TES) reference manual
 - TES high-level security policy, and TES Security Plan reference manual
 - Application Management reference manual
 - Application Development reference manual
 - Business Perspective reference manual
 - IT Strategic and Tactical Planning reference manual
 - Planning to Implement Service Management reference manual
 - Testing reference manual
 - Conformance Test procedure
 - Service Delivery reference manuals (Service Level, Availability, Continuity, Financial and Capacity management)

- Service Support reference manuals (Service Desk, Incident, Release, Change, Configuration, and Problem management), and related procedures
- Risk management reference manual
- ICT Infrastructure reference manual

Additionally, TEMPO provides for supporting documentation such as fact sheets, procedures, guides and templates.

5. CONSULTANT PROFILES - REQUIREMENTS

5.1. AREA OF ACTIVITY

DG TAXUD requires the services of intra muros consultants in all areas pertaining to its value chain (see section 4.6.1), covering the **support of project and service management, project support, BPM and IT analysis, enterprise, application and infrastructure architecture, operations, applications and security**. These services are applied to the Customs, Excise and Taxation environments.

These intra muros consultants will provide the referred services to one (or more) organisational entities described in section 4.7.

The Commission (and on its behalf, DG TAXUD) may not, under any circumstances, be considered to be the staff's employer or the freelancers' contractor and the said staff and, as the case may be, the said freelancers shall undertake not to invoke, in respect of the Commission, any right arising from the contractual relationship between the Commission and the Contractor.

5.2. PROFILES

For each profile the following information is provided:

<i>Task description</i>	These are examples of the tasks that will be expected of a person proposed with the required profile. This list is not exhaustive and is to be regarded as indicative only. The detailed task description will be defined in the technical annex of each Specific Contract.
<i>Experience and capability required</i>	A list of the minimal experience and capability that a person with this profile is required to possess.

For all profiles the following experience and capability are required:

- Ability to participate in multi-lingual meetings, ease of communication in front of large audiences;
- Capability to work into an international/multicultural environment;
- Rapid self-starting capability and experience in teamwork.

For certain profiles, a certificate is required. Certificates that differ only by being a higher version are considered identical.

5.2.1. PROJECT MANAGER (PROFILE P1)

A Project manager provides advice, guidance, consultancy and assistance to the official(s) responsible for the:

- management of one or more projects;
- management of the project team (and/or supervising the subcontractors' project team), the project plan and all the project management procedures.

Task description:

- Manage and follow-up a project or set of projects in some or all of the project life cycle phases (inception, plan, control and monitoring, closure); during the software development phase of the plan, to manage and follow up some or all activities (architecture, specifications, development, tests –including tests with Member States or other partners¹⁰, etc.);
- Set up and enforce the respect of organisation, procedures and project office tasks, raising warnings in case of non-respect of these;
- Coordinate the projects' various stakeholders (DG TAXUD business and IT teams, subcontractors teams, COTS providers, etc.);
- Enforce the quality delivery on schedule;
- Structure the information;
- Report on the project status (tasks progress, plan, actions, risks, issues, decisions, changes, etc.) within DG TAXUD and/or with Member States or other partners;
- Escalate issues, in particular the ones with potential impacts on time or resources;
- Produce and/or review documents;
- Provide suggestions for service or methodology improvements;
- Participate in meetings with DG TAXUD, contractors, Member States and/or other partners.

Experience and capability required:

- Minimum 5 years of recent project management experience;
- Experience with Project Management tools; willingness to use the project management tool and methodologies as specified by DG TAXUD;
- Strong organisational and co-ordination skills;

¹⁰ Some projects' stakeholders include candidate countries, third countries (e.g. USA, Russia), other directorates-general of the European Commission, Trade associations, etc.

- Ability to produce minutes, notes, business cases, vision documents, service level agreements, terms of collaboration, planning schedules, etc.
- Very good communication skills (including ability to present and to animate discussions), rapid self-starting capability and ability to work autonomously are mandatory;
- Experience of large scale systems integration projects, within IT and/or Taxation, Excise and Customs environment;
- Technical knowledge of the European Commission standard IT products (e.g. Oracle RDBMS, Weblogic server) is an asset;
- Experience in project coordination procedures, preferably involving a recognised methodology;
- Experience in international/multicultural environment is a definite asset;
- Experience in a public administration is an asset.

5.2.2. SERVICE MANAGER (PROFILE P2)

A Service manager provides advice, guidance, consultancy and assistance to the official(s) responsible for:

- the management of the development and implementation of services in order to meet the business needs;
- ensuring maximum uptime, accurate and early incident response, appropriate configuration management, proactive maintenance and tuning;
- the monitoring and reporting on operations and on capacity consumption, and liaison with all (internal and external) stakeholders;
- the management and coordination of the service desk activities and ensuring that incident, problem, change, configuration and release management is delivered according to quality plans (FQP) and according to quality levels agreed in the Service Level Agreement (SLA);
- the definition of KPIs and the monitoring and reporting on all quality indicators.

Task description:

- Set up and enforce the respect of organisation, procedures and project office tasks, raising warnings in case of non-respect of these;
- Enforce the quality delivery on schedule;
- Structure the information;
- Report on the service status (SLA, actions, risks, issues, decisions, changes, etc.) within DG TAXUD and/or with Member States or other partners;

- Escalate issues, in particular the ones with potential impacts on time or resources;
- Produce and/or review documents;
- Provide suggestions for service or methodology improvements;
- Participate in meetings with DG TAXUD, contractors, Member States and/or other partners.

Experience and capability required:

- Minimum 5 years of recent service management experience;
- Experience with service management tools; willingness to use the service management tools and methodologies as specified by DG TAXUD;
- Strong organisational and co-ordination skills;
- Ability to produce minutes, notes, service level agreements, terms of collaboration, planning schedules, etc.
- Good knowledge of ITIL, CMMI, SLA, OLA, SMT;
- Experience of large scale service support, service delivery and business continuity;
- Good technical knowledge on the projects aspects;
- Good reporting methods;
- Ability to give presentations;
- Ability to apply high quality standards to all tasks;
- Capability of understanding the needs, objectives and constraints of those in other disciplines and functions.

5.2.3. PROJECT SUPPORT EXPERT (PROFILE P3)

A Project support expert supports the smooth running of the project(s) from an organisational point of view, i.e. dealing with the respect of the procedures; follow up of the deliverable timetable, etc.

Task description:

- Coordinate and execute support activities;
- Assist with the planning and follow-up of the project;
- Enforce the schedule and deliverable timetable;
- Coordinate on project support matters, clarifying issues and preventing potential problems;

- Coordinate between the stakeholders;
- Participate in user, service and project meetings;
- Manage information sites;
- Promote information systems (IS);
- Organise and manage IS training;
- Write minutes of the meetings and list related actions resulting from the meetings;
- Technical drafting.

Experience and capability required:

- Good communication skills and ability to work autonomously are mandatory;
- Experience in standard project planning tools and methodologies (earned value, GANTT charts, critical path...);
- Experience in project coordination procedures, preferably involving a recognised methodology;
- Design, setting-up and maintenance of project reporting systems in large organisations, evaluating quality of project deliverables;
- Minimum 5 years of recent professional experience in IS project support or service management;
- Ability to cope with the needs of a multi-language environment;
- Ability to participate in multi-lingual meetings;
- Strong organisational skills needed;
- Notions of information broadcast;
- Experience in IS support is an asset.

5.2.4. BPM ANALYST (PROFILE P4)

A BPM analyst supports the various activities of business process analysis and design.

Task description:

- Produce technical annexes for the required modelling activities to be performed by the relevant external system supplier and validate the correctness of the reply from an IT technical viewpoint;
- Produce or maintain all required artefacts related to the analysis of business processes, business services and business data;

- Produce or maintain all required artefacts related to requirements analysis. This covers business requirements, IT functional and IT non-functional requirements;
- Produce or maintain all required artefacts related to business testing. This mainly implies the definition of the business scenarios to run;
- Produce or maintain required artefacts related to the training for a given IT system or application. This mainly implies the definition of the required business scenarios to cover during the training;
- Validate the required quality of a given business analysis activity performed by another contractor;
- Participate to meetings, workshops, brainstorming with DG TAXUD, other Commission contractors, Member States and/or other partners.

Experience and capability required:

- Minimum 5 years of recent practical BPM analysis experience
- Excellent written and verbal communication skills;
- Knowledge and experience with project management lifecycles and deliverables.
- Strong overall knowledge and experience in business process analysis and design;
- Specific customs, indirect or direct taxation business knowledge;
- Knowledge and experience of designing business processes using the BPMN and UML languages. Being an OMG certified expert in BPM is an asset;
- Knowledge and experience in the use of modelling and design tools in business projects (ARIS, Enterprise Architect, etc.);
- Knowledge and experience in business data modelling. Knowledge of models which are internationally supported such as the WCO data model, etc. is an asset.

5.2.5. IT ANALYST (PROFILE P5)

An IT analyst supports the various activities of IT analysis and design.

Task description:

- Produce technical annexes for the required analysis activities to be performed by the relevant external system supplier and validate the correctness of the reply from an IT technical viewpoint;
- Produce or maintain all required artefacts related to requirements analysis. This covers business requirements, IT functional and IT non-functional requirements;
- Produce or maintain all required artefacts related to IT analysis. This covers IT process analysis, IT service analysis, IT data analysis, use case analysis, etc.;

- Produce or maintain all required artefacts related to functional and non-functional testing. This mainly implies the definition of the IT functional and non-functional tests to perform;
- Produce or maintain required artefacts related to the training for a given IT system or application. This mainly implies the definition of functional scenarios to cover during the training;
- Validate the required quality of a given IT analysis activity performed by another contractor;
- Participate to meetings, workshops, brainstorming with DG TAXUD, other Commission contractors, Member States and/or other partners.

Experience and capability required:

- Minimum 5 years of recent practical IT analysis experience;
- Excellent written and verbal communication skills;
- Knowledge and experience with project management lifecycles and deliverables.
- Strong overall knowledge and experience in IT analysis and design;
- Strong knowledge of and experience in IT analysis processes based on SOA such as Mainstream SOA Methodology, etc.;
- Acquire in a fast way the knowledge of the required methodologies to be applied and prescribed by the Commission (TEMPO, RUP@EC and any successors of these methodologies). An evolution towards applying SOA from an analysis viewpoint will be required;
- Specific customs, indirect or direct taxation business knowledge is an asset;
- Knowledge and experience in tools supporting the IT process, service and data analysis activities such as ARIS (from Software AG), the IBM Rational tool suite, etc.;
- Knowledge of application development environments;
- Have familiarity with software design/development processes, and the ability to communicate effectively with the development team.

5.2.6. ENTERPRISE ARCHITECT (PROFILE P6)

An Architect has an overall view of the TAXUD IT systems or of a significant subset of them. S/he performs high level and/or core design, ensures interoperability and identifies potential reuse. S/he is supervising the overall consistency of IT architecture within TAXUD and guarantees that its design fulfils a set of requirements. An **Enterprise architect (EA)** covers IT and business aspects. The latter including mission, value chain, business strategy, business processes, functions and data. The former aspect covers the “IT solution” needed to support the business.

Task description:

- Propose systems, components and/or services architecture (e.g. SOA, ESB, MDM, legacy, framework, security), COTS software products, standards; and/or to evaluate technical offers of TAXUD contractors;
- Make proposals for architecture governance and/or to evaluate technical offers of TAXUD contractors;
- Investigate and recommend solutions (including cost benefit analyses, assessment of implementation's duration); and/or to evaluate technical solutions proposed by TAXUD contractors;
- Understand, apply and suggest improvements of TAXUD methodology, security policies, tools, best practices, etc.
- Support projects by designing services and components (or supervising contractors' design), encouraging re-use and by committing that the design of the system will fulfil the system's requirements, in particular non-functional requirements (volume, scalability, confidentiality, integrity, availability);
- Ensure that the systems, components and/or services' design is consistent with TAXUD architecture (e.g. consistency with a TAXUD framework);
- Analyse the integration of different information systems and ensure their interoperability.
- Provide advice and consultancy;
- Participate in brainstorming, meetings and workshops with DG TAXUD, contractors, Member States and/or other partners;
- Produce and/or review documents. This includes system and application architecture documents.

Experience and capability required:

- Good communication skills and ability to work autonomously are mandatory;
- Minimum 5 years of recent practical experience in IT systems architecture and design;
- Capability for modelling components, data and services;
- Capability for specification of service interfaces, service data and reference models;
- Good knowledge of interoperability technology (e.g. web services, message oriented middleware, service oriented bus);
- Capability for modelling service data and reference models;

- Good knowledge of service implementation patterns (synchronous, asynchronous, request/response, etc), distributed system design and messaging layer;
- Ability to cope with fast-changing technologies used in application architecture;
- Very strong capability for analysis, comparison and summary;
- Strong capability for writing and presentation of clear documents;
- Experience in architecture modelling tools;
- Experience in international/multicultural environment and public administration are assets.
- Deep technical knowledge of IT technology;
- Motivational skills. EAs must be able to motivate and inspire. A large part of the job is to influence a set of ideals in the environment;
- Negotiation skills. EAs must negotiate to get things accomplished. EAs are individual contributors and do not have organisational power;
- Critical Thinking. Being able to think quickly and on your toes is often required;
- Problem Solving. EAs often face a set of complex and unique problems, so they must be able to evaluate and solve problems;
- Big Thinking. Avoiding tunnel vision and being able to look at a problem from multiple angles;
- Business savvy. Knowing the industry in which you work is essential, to help you understand how the technology can really affect the business;
- Process Orientation. Thinking in terms of process is essential for an EA;
- Large-scale programme oversight. Programmes are multiple related projects represented as a package. Managing programmes requires a person that is able to handle multiple aspects of a project at one time.

5.2.7. APPLICATION ARCHITECT (PROFILE P7)

An Architect has an overall view of the TAXUD IT systems or of a significant subset of them. S/he performs high level and/or core design, ensures interoperability and identifies potential reuse. S/he is supervising the overall consistency of IT architecture within TAXUD and guarantees that its design fulfils a set of requirements. An **Application architect** covers both business-agnostic components (e.g. guaranteed message delivery, protocol conversion, message transformation, identity and access management) and business applications (e.g. Customs Tariff, Excise EMCS, Taxation VIES).

Task description:

- Propose systems, components and/or services architecture (e.g. SOA, ESB, MDM, legacy, framework, security), COTS software products, standards; and/or to evaluate technical offers of TAXUD contractors;
- Investigate and recommend solutions (including cost benefit analyses, assessment of implementation's duration); and/or to evaluate technical solutions proposed by TAXUD contractors;
- Understand, apply and suggest improvements of TAXUD methodology, security policies, tools, best practices, etc.
- Support projects by designing services and components (or supervising contractors' design), encouraging re-use and by committing that the design of the system will fulfil the system's requirements, in particular non-functional requirements (volume, scalability, confidentiality, integrity, availability);
- Ensure that the systems, components and/or services' design is consistent with TAXUD architecture (e.g. consistency with a TAXUD framework);
- Follow up projects to control that the systems, components and/or services' implementation sticks to the approved design;
- Analyse the integration of different information systems and ensure their interoperability.
- Provide advice and consultancy;
- Participate in brainstorming, meetings and workshops with DG TAXUD, contractors, Member States and/or other partners;
- Produce and/or review documents. This includes system and application architecture documents.

Experience and capability required:

- Good communication skills and ability to work autonomously are mandatory;
- Minimum 5 years of recent practical experience in IT systems architecture and design;
- Capability for modelling components, data and services;
- Capability for specification of service interfaces, service data and reference models;
- Good knowledge of interoperability technology (e.g. web services, message oriented middleware, service oriented bus);
- Capability for modelling service data and reference models;
- Good knowledge of service implementation patterns (synchronous, asynchronous, request/response, etc), distributed system design and messaging layer;

- Ability to cope with fast-changing technologies used in application architecture;
- Very strong capability for analysis, comparison and summary;
- Strong capability for writing and presentation of clear documents;
- Experience in architecture modelling tools;
- Experience in international/multicultural environment and public administration are assets.
- Experience in architecture methodology and framework (e.g. TOGAF);
- In-depth knowledge of service implementation patterns (synchronous, asynchronous, request/response, publish and subscribe, etc.), distributed system design and messaging layer;
- Deep technical knowledge of IT technology; the list of possibly required skills for a specific position includes but is not limited to:
 - Interoperability: SOA, ESB, MOM
 - Master Data Management
 - IT protocols: MQ Series, WS, HTTP(S), SMTP, SNMP, etc.
 - EDIFACT, XML, XSLT, etc.
 - Identity and Access Management

5.2.8. INFRASTRUCTURE ARCHITECT (PROFILE P8)

An Architect has an overall view of the TAXUD IT systems or of a significant subset of them. S/he performs high level and/or core design, ensures interoperability and identifies potential reuse. S/he is supervising the overall consistency of IT architecture within TAXUD and guarantees that its design fulfils a set of requirements. An **Infrastructure architect** participates in key organisational IT infrastructure initiatives. S/he provides infrastructure system engineering and architecture specifications; ensures that processes and documentation are adequate and effective to meet specifications and audit requirements; supports DG TAXUD officials by dealing with IT vendors to ensure timely and excellent delivery of services.

Task description:

- Propose systems, components and/or services architecture, COTS software products, standards; and/or to evaluate technical offers of TAXUD contractors;
- Make proposals for architecture governance and/or to evaluate technical offers of TAXUD contractors;
- Investigate and recommend solutions (including cost benefit analyses, assessment of implementation's duration); and/or to evaluate technical solutions proposed by TAXUD contractors;

- Understand, apply and suggest improvements of TAXUD methodology, security policies, tools, best practices, etc.
- Support projects by designing services and components (or supervising contractors' design), encouraging re-use and by committing that the design of the system will fulfil the system's requirements, in particular non-functional requirements (volume, scalability, confidentiality, integrity, availability);
- Ensure that the systems, components and/or services' design is consistent with TAXUD architecture;
- Follow up projects to control that the systems, components and/or services' implementation sticks to the approved design;
- Provide advice and consultancy;
- Participate in brainstorming, meetings and workshops with DG TAXUD, contractors, Member States and/or other partners;
- Produce and/or review documents. This includes system and application architecture documents.

Experience and capability required:

- Good communication skills and ability to work autonomously are mandatory;
- Minimum 5 years of recent practical experience in IT systems architecture and design;
- Capability for modelling components, data and services;
- Capability for specification of service interfaces, service data and reference models;
- Good knowledge of interoperability technology (e.g. web services, message oriented middleware, service oriented bus);
- Capability for modelling service data and reference models;
- Good knowledge of service implementation patterns (synchronous, asynchronous, request/response, etc), distributed system design and messaging layer;
- Ability to cope with fast-changing technologies used in application architecture;
- Very strong capability for analysis, comparison and summary;
- Strong capability for writing and presentation of clear documents;
- Experience in architecture modelling tools;
- Experience in international/multicultural environment and public administration are assets.

- Proven experience of high availability systems design;
- Deep technical knowledge of IT technology - the list of possible required skills for a specific position includes, but is not limited to:
 - Networking technologies: Cisco Nexus; Load balancing technologies; Converged networks
 - Security technologies: Juniper firewalls, IPSec
 - Virtualisation technologies: Solaris zones, AIX LPAR, VMware Vmotion
 - Database systems: Oracle DB, Oracle RAC
 - Storage and backup systems: Legato, VTL, EMC
 - Operating Systems: IBM AIX, Oracle Solaris, Red Hat Linux, Windows
 - Monitoring platforms: Tivoli
 - Middleware: Oracle OSB, Tuxedo, MQseries

5.2.9. OPERATIONS EXPERT (PROFILE P9)

An Operations expert supports the installation, running-in, operation and decommissioning of IT systems, including hardware, operating system, storage, backup, middleware, database, COTS and applications.

Task description:

- Support IS Service management;
- Define policies and standard operating procedures to be used by the service management;
- Support Service Operations (ITIL lifecycle) processes: Incident management and Problem management;
- Support Service Transition (ITIL lifecycle) processes, especially in Change management;
- Participate in meetings with DG TAXUD, contractors, Member States and/or other partners.

Experience and capability required:

- Good communication skills and ability to work autonomously are mandatory;
- Proven experience in IS operations and related methodologies, especially ITIL.
- Proven technical knowledge in support of information systems and operational environments; technical knowledge in Web logic, Oracle, Solaris and Red Hat Linux is an asset;
- Minimum 5 years of recent IT operations professional experience;
- Ability to cope with the needs of a multi-language environment;
- Ability to cope with the fast changing technologies and security concerns;

- Capable to produce concise technical documentation.

5.2.10. APPLICATION EXPERT (PROFILE P10)

An Application expert supports the development, maintenance, testing, operational roll-out and operational follow-up of IT systems and applications in the field of Customs, Excise and Taxation.

Task description:

- Support the impact analysis of Requests for Change for the existing IT systems and applications.
- Support the preparation and participate to the consequent Change Advisory Board;
- Produce the IT technical annex for Request for Estimates to be issued by DG TAXUD to other contractors and validate the correctness of the reply from an IT technical viewpoint;
- Produce or maintain all artefacts required to build and test a given IT system or application release. The required artefacts have to be compliant to the agreed contractual descriptions and the TEMPO methodology;
- Validate the required quality control points of a given IT system or application release. These quality control points can be of a binding nature or agreed with the contractors supplying the development or operational services. The related tasks are review of specification or testing artefacts, validate if software implementations are compliant with the agreed specifications, validate if the software implementations are fit for deployment, etc.;
- Support the different operational services for a given IT system or application: incident management, problem management, etc. at a third level. In general, the expert acts as a coordinator between different stakeholders for a given operational service;
- Assist with training of the systems administrators and users.
- Participate in brainstorming, meetings and workshops with DG TAXUD, other contractors, Member States and/or other partners.

Experience and capability required:

- Minimum 3 years of recent practical experience in IT systems design;
- Have IT analysis skills and the ability to translate IT requirements.
- Being expert with software design/development processes and tools, and the ability to communicate effectively with the development team.
- In depth knowledge of application development environments.

- Have the capacity to understand IT architecture solutions in general and IT architecture models specifically.
- In depth knowledge of the SQL as the database access language in a given DBMS implementation (currently Oracle at the Commission level).
- Acquire in a fast way the knowledge of the required methodologies to be applied and prescribed by the Commission (TEMPO, RUP@EC and any successors of these methodologies). An evolution towards applying SOA from an analysis viewpoint will be required.
- Ability to cope with fast-changing technologies used in information systems developments.
- Working knowledge of Java development techniques and technologies.
- Technical knowledge of IT technology; the list of required skills for a specific position includes but is not limited to:
 - Interoperability: SOA, ESB, MOM
 - Master Data Management
 - IT protocols: MQ Series, WS, HTTP(S), SMTP, SNMP, etc.
 - EDIFACT, XML, XSLT, etc.
 - Identity and Access Management

5.2.11. SECURITY EXPERT (PROFILE P11)

A Security expert assists and advises the IT Units described in section 4.7 in any area and domain related to information security, in close collaboration with the LISO. The security expertise can range from policy-making to operational control, architectural design, training, products and technologies' knowledge with a concern to update and maintain it.

Task description:

- Assist DG TAXUD in the follow-up and co-ordination of IT Security-related matters, acting as a facilitator to converge all efforts towards the project's objectives;
- Translate security requirements into technical requirements;
- Verify compliancy of DG TAXUD's information and information systems with the European Commission security policy;
- Review the quality and conformance of the technical deliverables (specification, software, documentation, security plans) and services with a focus on security and continuity;
- Follow up the operations and advice on business continuity and disaster recovery;
- Assist DG TAXUD in the definition of its Information Systems Security Management (ISMS);
- Clarify issues and prevent potential security incidents;
- Perform technical security assessment and studies;

- Participate in meetings with DG TAXUD, contractors, Member States and/or other partners.

Experience and capability required:

- Good communication skills and ability to work autonomously are mandatory;
- Minimum 5 years of recent IT security experience and an appropriate knowledge of the current state-of-the-art technical evolution in security management and related products;
- Familiarity with IT projects, preferably in the field of Excise, Customs and Taxation business or accounting;
- Ability to review technical and security documents; experience with security assessment of information systems;
- Experience in international/multicultural environment and public administration are assets;
- Experience with software development;
- Experience with security methodologies, risk management & audits (such as ISO17799/27001, Cramm/Ebios, CobIT);
- Extensive knowledge of TCP/IP and network protocols;
- Experience with cryptography, network security, identity and access management (IAM), desktop tools and products for security assessments and audits;
- Knowledge of Commission legislation and policies on security and risk management;
- CISSP and/or CSSLP certification is an asset;
- Additional desirable assets: experience in ITIL, experience in implementation and enforcement of Service Level Agreements (SLA), experience as a technical writer.

6. ADMINISTRATIVE PROCEDURES

6.1. ORDERING PROCESS

Services shall be provided on the basis of Time & Means orders, which correspond to the order of a number of days to be performed at the Commission premises.

The ordering process is initiated by the Commission services via a request sent to the contractor describing the required services. On receipt, the contractor must, within a given time period, make an offer to the Commission services for the execution of the request. The process culminates in the signature of a specific contract (i.e. an order), or in the withdrawal of the request form.

The chosen contractor must have the administrative and technical capacity to carry out in parallel several individual orders. The contractor must be capable of providing on time the services ordered and with a high degree of quality. A service level agreement (Annex XI to the Tendering Specifications) describes the required quality service levels.

The TIMEA2 framework contract will be managed by the PS sector of DG TAXUD/R4 of the European Commission.

6.2. TIME AND MEANS ORDERS

Time & Means orders are executed at the Commission's premises (i.e. intra muros).

In a Time & Means order the Commission specifies the workload (e.g. person-days) and the specific needs for the requested profiles.

The following conditions relating to Time & Means (TM) orders apply:

The contractor must present offers meeting the requirements as specified in the request and associated documents. The persons proposed by the contractor must match the requested profile description and the specific needs indicated in the request form.

The contractor must be able to propose at least two qualified persons per requested profile for the choice of the Commission.

Pre-defined CV forms¹¹ must be used. All information indicated in the CV has to be correct and validated.

Persons proposed by the contractor must be available for interviews in the short term (within 10 working days).

Persons proposed by the contractor must be available at the start of the project, as stipulated in the request for offer.

¹¹ CV form must follow the template as indicated in the following link:
<http://europass.cedefop.europa.eu/en/documents/curriculum-vitae/templates-instructions>

Work is performed at the Commission premises when not specified otherwise. In some cases, on request of the Commission, missions outside the normal location can be required. A prior written authorisation of the Commission is necessary before any such travel. During those missions outside the Commission premises, the intra muros consultants/the contractor's personnel may not under any circumstances represent the Commission/DG TAXUD.

On demand by the Commission, the contractor must replace personnel who prove incapable of carrying out the specified tasks to the required standards. The replacement candidate will be given sufficient training during an adequate handover period, so that he/she can be immediately operational when the original candidate is withdrawn. Any such replacement and training, if required, will be carried out at no additional cost to the Commission. The candidate will not in any case attend Commission training courses for EU staff.

The contractor shall give a month's notice to the Commission of any personnel changes in the team. The contractor will have to obtain the prior agreement of the Commission on those personnel changes in the team.

- In case of *force majeure*, if the original person is no longer able to carry out the work, the contractor is obliged to inform the Commission, to provide immediately a competent replacement person and to arrange sufficient training (during an adequate handover period where possible), so as to guarantee continuity of the service provided to the Commission. Any such replacement will be effected at no additional cost to the Commission.
- In case of replacement, the handover period must be at least 10 working days, free of charge for the Commission. If no handover is possible and additional training is needed for the replacement person, at least 15 working days, free of charge for the Commission, must be performed by the replacement person. The candidate will not in any case attend Commission training courses for EU staff.

In case of replacement, the contractor must propose a minimum of two replacement persons with the required qualifications and experience for the profile. If the contractor does not propose suitable replacement persons, the Commission may immediately terminate the specific contract.

On request of the Commission, during holidays or other periods of planned absence by the person employed, the contractor will be required to provide an adequate replacement. The Commission cannot and will not intervene in the management of holidays or other periods of absence (i.e.: sickness, maternity leave, other leaves) of the contractor's personnel, but only on the effectiveness of the replacement/s and of the continuity of the service. The replacement person will be given sufficient training and provided with all information necessary to guarantee continuity of the service provided to the Commission. All such training and handover work will be carried out at the contractor's expense. The candidate will not in any case attend Commission training courses for EU staff.

The contractor is responsible in all cases for ensuring business continuity of the services it delivers to the Commission.

If the selected person is no longer available, the contractor is obliged to inform the Commission immediately. If the specific contract is not yet signed by both parties the contract will not be signed. If the specific contract is already signed, the Commission can either cancel the contract or ask for a replacement with the performance of 10 working days free of charge.

Invoicing is based on the number of days performed.

Remarks:

- One full year corresponds to an effective workload of maximum 220 days.
- The request form can combine different profiles, with the requested quantity for each profile and the individual workload.

6.3.INTERFACES, ROLES AND RESPONSIBILITIES

On the contractor's side

- The contractor nominates a contract manager in charge of the framework contract. He will be responsible for all contractual relations with the Commission. The contract manager must be reachable by the Commission during working hours. In case of absence, a back-up person has to be designated.
- The contractor nominates persons authorised to sign the specific contracts under the responsibility of the contract manager.
- The contractor has to designate a contact person, and at least a back-up person in case of absence, who will take care of all requests addressed by the Commission.
- The contractor provides a single contact office with telephone number, postal address, e-mail address.
- The contractor must communicate the list of all persons in charge of the customer's relationship management with the services of the Commission.

On the Commission side

- The **Director TAXUD/R** represents the Contracting authority for the Commission. He signs the framework contract, all specific contracts and all their amendments.
- The **Head of TAXUD Unit R1** (Financial Manager) is responsible for the legal follow-up of the framework contract and will act as the contact person for all general legal aspects linked with the framework contract and the specific contracts. He is also responsible for all financial aspects related to the execution of the framework contract and the specific contracts.
- The **Head of TAXUD Unit R4** (Service Manager) is responsible for the technical follow-up and the quality management of the contract and will be the contact person for all procedural and reporting aspects linked with the framework and specific contracts.

- The **contact person** is the person in charge of a specific request sent to the contractor.
- The **DG TAXUD administrative official** is the person responsible for administrative matters in the execution of a specific contract.
- The **DG TAXUD technical official** is the person responsible for technical matters in the execution of a specific contract.
- The **Informatics Resource Manager (IRM)** is responsible for informatics in a DG.

6.4.SERVICE MEETINGS

At the request of the Commission or of the contractor, follow-up meetings between the Commission representatives and the contractor's representatives could be held at the Commission premises.

They could be held on a quarterly or an annual basis depending on the volume of the activities.

When necessary, special meetings on a particular subject related to the implementation of the contract can be requested by the Commission or the contractor. The composition of the Commission participation will depend on the purpose and the subject of the meeting.

6.5.SECURITY CLEARANCE

In exceptional cases, when required by the Commission services for security reasons, the Commission may make a specific request to contractors that they agree to a security clearance of the persons involved for the provision of certain services. This will be considered as a specific requirement for a specific project, and will not influence the other conditions.

6.6.EXCHANGE OF DOCUMENTS

The involved actors are the contractor and the Directorate-General for Taxation and Customs Union (DG TAXUD).

At the start of the framework contract, e-mail will be the official means for exchange of all documents between DG TAXUD, initiating a request and the contractor.

All the contractors' documents should be made available in a PDF electronic format.

An electronic procedure will be used for the copying of all contractors' documents in a PDF format to be forwarded to the Commission.

No specific installation is required from the contractor, apart from a usable Internet connection, and a specific e-mail address.

All documents transmitted by the contractor must indicate the Commission references, the contractor's own references, the type of document (receipt confirmation, offer), the

subject, the title. The name of the electronic documents should always contain the type of document (e.g. RC, Offer), DG TAXUD and the contractor's/contract's reference.

All documents transmitted by the contractor and its personnel to DG TAXUD will use the letterhead of the contractor. All e-mails sent by the contractor and (its) personnel to the Commission/DG TAXUD staff will use the e-mail signature of the contractor.

The contractor and its personnel may not under any circumstances use the headings, letterheads or e-mail signatures of the Commission/DG TAXUD.

6.7.ROADMAP FOR TIME & MEANS PROJECTS

DG TAXUD will issue to the contractor a request for offer under the Framework Contract. The contractor will propose, within a contractual response time, a list of suitable qualified CVs for the consideration of DG TAXUD. DG TAXUD will invite the contractor to present selected candidates for interview. DG TAXUD will then inform the contractor of the successful candidate(s) and invite it to confirm the availability of those candidate(s) for a defined period. Following such confirmation, DG TAXUD will take steps internally to draft a specific contract for the services required from the chosen candidate.

The primary responsibility of the contractor is to provide consultants with individual skills that match the needs of DG TAXUD. DG TAXUD reserves the right to reject consultants proposed by the contractor.

The following rules shall apply to requests for supplying consultancy services.

- For each case, DG TAXUD will specify the consultancy services required, hereinafter referred to as project, and remind the contractor of the relevant response time. The contractor will make its offer in response to DG TAXUD's specifications within the time limit.
- If the contractor provides a list of suitable consultants (at least two) within the response time and those consultants meet the profile requirements, then the contractor will be awarded the services in question.
- If the contractor does not provide a list of consultants within the response time or is unable to meet the profile requirements, then it will be regarded as unable to supply the consultancy services requested.

Remark: In the following description of the procedures, the term “fault” refers to a contractor procedural error and not to the quality of the content of the documents.

Step 1: Need arises

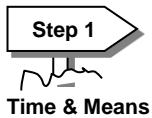

What	<p>The need for some Time & Means IT service arises.</p> <p>DG TAXUD prepares the profile's requirements / specifications.</p> <p>DG TAXUD also specifies how much time it wants to allow the contractor to prepare its offer with a list of the qualified persons it proposes. The time allowed to the contractor must be at least 3 working days as from the “request date”. This date, by which the contractor must present its list of proposed qualified persons, is referred to as the “list presentation date”.</p>
Parties involved	DG TAXUD.
Result	<ul style="list-style-type: none"> • Requirements. • “List presentation date” deadline is fixed.
Fault	None.

Step 2: Send request form

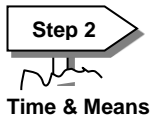

What	<p>DG TAXUD e-mails the request to the Contractor. The date on which DG TAXUD e-mails the request form is referred to as the “request date”.</p>
Parties involved	DG TAXUD.
Result	<ul style="list-style-type: none"> • “Request date” is fixed. • “List presentation date” is fixed. • Request is e-mailed.
Fault	None.

Step 3: Request receipt confirmation

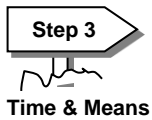

What	The contractor receiving the request acknowledges reception within 2 working days of the day the request was sent, by sending an e-mail to DG TAXUD.
Parties involved	Contractor.
Result	Request confirmation of receipt sent within 2 working days of “request date”.
Fault	Not respecting the deadline by which the receipt confirmation must be sent.

Step 4: Presentation of candidates list

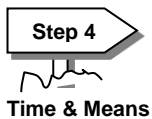

What	<p>The contractor sends an offer containing a list of candidates (at least two) having the required profiles by e-mail by the “list presentation date” to DG TAXUD.</p> <p>The list will include for each candidate the name, the date when the candidate is available, the candidate’s profile, whether the candidate is offered via subcontracting, whether the candidate is permanently employed by the contractor and any other relevant information.</p> <p>The CVs of all proposed candidates must be attached to the list e-mailed to DG TAXUD. All candidates on the list must be available for interview within 10 working days following the sending of the list.</p> <p>If the contractor does not send this list to DG TAXUD by the “list presentation date”, DG TAXUD may consider this as not respecting the requirements, and go back to step 2.</p>
Parties involved	<ul style="list-style-type: none"> • Contractor. • DG TAXUD.
Result	List with proposed qualified candidates.
Fault	Not respecting the “list presentation date” (even if DG TAXUD accepts the proposed list).

Step 5: Finalisation of the offer

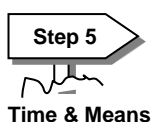

What	<p>The period after the “list presentation date” can be used by the contractor and the DG TAXUD to organise meetings to present and interview the persons proposed.</p> <p>If DG TAXUD accepts a candidate from the list, an e-mail will be sent to the contractor indicating that the candidate is accepted and this is to be regarded as a request for a formal offer.</p> <p>If the candidates on the list do not correspond to the requirements, DG TAXUD will inform the contractor by e-mail, with justification, that the candidates do not correspond to the requirements and goes back to Step 2.</p>
Parties involved	<ul style="list-style-type: none">• Contractor.• DG TAXUD.
Result	Candidate(s) accepted.
Fault	None.

Step 6: Establishment of the specific contract

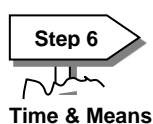

What	<p>The contractor sends a formal offer to DG TAXUD concerning the chosen candidate(s).</p> <p>The specific contract is established based on the formal offer. It will include details of the work to be carried out, the start date, the duration in days and any other relevant information.</p>
Parties involved	<ul style="list-style-type: none">• Contractor.• DG TAXUD.
Result	Specific contract signed.
Fault	None.

Step 7: Execution of the Specific Contract

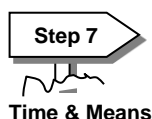

What	The task(s) as requested in the order is/are carried out by the contractor under the technical supervision of tDG TAXUD.
Parties involved	Contractor. DG TAXUD.
Result	Successful completion of the task(s).
Fault	The tasks are not successfully completed.

Step 8: Acceptance

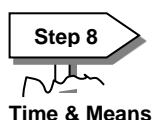

What	The acceptance is based upon the signature of the timesheet.
Parties involved	<ul style="list-style-type: none">• Contractor.• DG TAXUD.
Result	The contractor's invoice(s) is/are paid by the Commission
Fault	None.

6.8.REPORTING

The contractor must submit quarterly reports in English to the responsible service manager at DG TAXUD (Head of Unit TAXUD/R4), in the lay-out given below.

The report, with complete and accurate information as of the end of a quarter, must be delivered at the latest on the 16th of the following month. The content and layout requirements of the report may change over time. The contractor will align its report accordingly.

The report will include:

- up-to-date list of contact points in the organisation of the contractor for the delivery of the services;
- data on the request processing and specific contracts from the start of the framework contract as well as measures taken to keep the consultants' expertise at a high level including information on training provided to experts;
- identified risks, problems, mitigating measures taken, etc.

- The values of quality indicators defined in Annex XI to the Tendering Specifications (SLA)
- A summary of the activities, including a description of how the contractor's staff has fulfilled tasks specified in the technical annexes of the specific contracts.

The reports will only use the letterhead of the contractor. The reports may not under any circumstances use the headings, letterheads or e-mail signatures of the Commission/DG TAXUD.

Failing to provide this information in this form will be considered a reporting fault. `

DG TAXUD will monitor the quality of the service provided by the contractor.

DG TAXUD may request the contractor's attendance at progress meetings that are scheduled to take place in Brussels once every three months.

Elements that will be monitored include:

- The efficiency in providing persons with the requested profiles;
- The quality of the persons and adherence to the profile requirements;
- The swiftness of the responses to orders;
- The respect of deadline dates;
- The quality of the contractor's administration;
- The follow-up and service management of the contractor's consultants.

6.9.REPORTING TEMPLATES

Request Processing and specific contracts data

Framework Contract N°:	Date sent:
	Report for period:
Contractor:	Contact Person Name: Phone: e-mail:

Request history for Time and Means orders. The requests must be entered in the order of their reception. If a request deals with more than one profile or person, use multiple lines to describe them all.

The columns marked (RF) can be filled in upon reception of the Request Form.

Form ID (if extension: indicate ext. and reference of initial order)	Requested profile	Number of days	Date request e-mailed (dd/mm/yy)	Remarks on quality of proposed CVs	Requested start date	Effective start date	Name of person that started	Name of subcontractor (if applicable)
(RF)	(RF)	(RF)	(RF)		(RF)			

Specific Contract history for Time and Means orders					
Commission's Request Form ID	Number of days of request form	Specific contract n° and amendment n°	Number of days of specific contract / amendment	Name of person working on the contract	Remarks on execution of the contract (replacements, interruptions etc)

History of measures to keep expertise of consultants at a high level	
Name of person working on the contract	Training followed (subject, period and duration) or other measure taken

Requests and offers summary

Give cumulative value from the start of the contract

Year/Month	Number of requests received	Number of offers accepted by the Commission	Number of offers refused by the Commission	Number of requests withdrawn by the Commission	Number of offers in Progress	Number of offers with unknown status

Month	Number of new Specific Contracts	Number of time & means contracts	Number of subcontracted consultants	Number of permanent staff working in time & means	Number of non-permanent staff working in time & means

Specific Contracts in progress

Give the figures at the end of the month

Month	Number of Specific Contracts in progress	Number of time & means in progress	Number of subcontracted consultants	Number of permanent staff working in time & means	Number of non-permanent staff working in time & means	Number of replacements (in time & means)	Number of Specific Contracts finished during the month

Summary of the activities including a description of how the contractor's staff has fulfilled tasks specified in the technical annexes of the specific contracts.

--

7. DELIVERY

7.1.PLACE OF DELIVERY AND MISSIONS

The delivery of services will take place at Commission's premises, in Brussels, Belgium or Luxembourg. This type of delivery is thus called on-site or intra muros delivery.

The personnel providing the service will use only the standard software packages and hardware in use in / and provided by DG TAXUD, and no other software or hardware may be installed or used without the written authorisation of the Commission.

Travel costs and daily allowances associated with these deliveries shall be reimbursed in accordance with the rules defined in Annex X.B to the Framework Contract. In the case of travel, contractors shall invoice travel days at the normal daily rate for the relevant profile, as fixed in the Framework Contract.

As an exception, DG TAXUD may request delivery of services outside the normal locations of delivery.

7.2.WORKING HOURS

Delivery will mainly take place on normal working days and during normal working hours as defined in Article 1.1 of the General Terms and Conditions of Informatics Contracts attached to the Framework Contract.

By derogation to Article 1.1 of the General Terms and Conditions of Informatics Contracts, a person-day is defined as 8 (eight) hours. The contractor will ask its personnel delivering intra muros services to the Commission to fill in their time-sheets by only using the contractor's headed paper. A model timesheet is provided in Annex XII of the tendering specifications.

However, in exceptional cases and only on request of DG TAXUD, the necessity to deliver services outside the normal working days and the normal working hours may arise. For these exceptional situations the following surcharges will be applied/

- Service delivery on normal working days, but outside normal working hours: Surcharge of 50% of the applicable daily rate.
- Service delivery outside normal working days: Surcharge of 100% of the applicable daily rate.

The surcharges will only apply if at least 50% of a person-day is provided in the timeframe that allows a surcharge.

Surcharges also apply for effective working days delivered during travelling time.

Surcharges cannot be applied to Commission on-duty days (such as 2nd of January, Holy Thursday, Good Friday, the day following Ascension Day and the period between 27 and 31 December).

—24-hours on-call service:

DG TAXUD may request the contractor to provide a 24-hours on-call service. The service should be delivered by the same profile(s) providing the duties during normal working hours.

The 24-hour service may be requested for all profiles.

The profile(s) assuring this service will be on-call 24-hours a day (for 7 days per week) and may be requested to carry out interventions at the premises of the place of delivery for this profile.

The contractor shall take all the necessary provisions to ensure that the personnel in charge are reachable by mobile phone if requested.

The 24-hours on-call service will be payable at a fixed percentage of the daily rate of the profile of the person providing the service. If the person on call has to carry out interventions at the premises of the place of delivery, the intervention will be paid according to the applicable daily rate (surcharge rules above apply).

7.3.LANGUAGES

Consultants shall be capable of working in more than one official EU language¹². The required services must at least be provided in English (main working language of operational IT and business units). Knowledge of the French language is desirable. When necessary, additional language requirements may be stipulated in the request.

7.4.TRAINING

As a rule, DG TAXUD will not take charge of the training of the contractor's staff. The contractor's staff will not in any case attend Commission training courses for EU staff.

When needed, general informatics training courses must be followed outside the Commission premises.

The contractor is asked to plan a minimum of 5 days of training courses per year for each member of its staff working in the Commission premises. These training days cannot be charged by the contractor to DG TAXUD. The full cost of these training will be borne by the contractor. Only in exceptional cases (e.g. if the training course is not provided externally) and on specific written request by DG TAXUD, the contractor's staff working for a time and means contract may follow an informatics or non-informatics (e.g. Commission-specific business procedures or Commission-specific application functionalities) training course organised by the Commission, at no cost for the contractor. However, such training days cannot be charged by the contractor to DG TAXUD.

¹² http://ec.europa.eu/languages/languages-of-europe/eu-languages_en.htm

8. OTHER REQUIREMENTS

8.1.AVAILABILITY

Each proposed consultant must be available for the duration of the specific contract.

Since there is a considerable learning curve in understanding the nature of the business and the guidelines to be used, it would be detrimental to the quality of the work if this could not be achieved.

In any event, both parties must agree any consultant's replacement. DG TAXUD reserves the right to reject consultants proposed by the contractor with due justification.

8.2.PROCEDURES DOCUMENTATION

The contractor shall ensure that all procedures are fully documented.

All documentation relating to the execution of the service shall be handed over at no cost to DG TAXUD upon request at any time during the period of implementation of the contract.

8.3.CONFIDENTIALITY

The contractor must declare in writing that its consultants working intra muros at DG TAXUD will respect the confidentiality of all information brought to their attention during the performance of their work and that they will not divulge to third parties or use for their own benefit or that of any third party any document or information not available publicly, even after completion of their assignment.

This obligation will continue after the end of the specific contract. The contractor must include a clause to this effect in its contractual relationship with its consultants assigned to DG TAXUD. The contractor shall provide evidence to DG TAXUD of this obligation.

To this end, the standard "**Declaration of Confidentiality and Compliancy**" (Annex VI to the Tendering Specifications) shall be used and signed by each consultant assigned to DG TAXUD.

8.4.DELIVERABLES

The deliverables will be the quarterly reports and the monthly signed timesheets.

The contractor will collect and verify from its consultants all timesheets of a given month and will then send the bundle directly to DG TAXUD for approval. The consultants will, therefore, not submit their timesheets directly to DG TAXUD officials for approval.

Invoicing terms will be the formal acceptance of three consecutive monthly timesheets.

8.5. OWNERSHIP

All deliverables produced by the contractor and/or by intra muros consultants become the property of the Commission, which will be the only party that can authorise their further use and distribution.

9. PORTFOLIO OF SYSTEMS, APPLICATIONS, AND IT SERVICES FOR CUSTOMS (UPDATED 3/2013)

Important note: the information provided below is an extract from the CUSTDEV3 call for tender terms of reference.¹³ It aims at giving the tenderers a full, clear and precise description of the Customs environment.

This section provides information on:

- DG TAXUD business environment;
- Architecture and strategy background;
- Customs business and modelling background;
- The portfolio of DG TAXUD TES and applications;
- The foreseen evolution of the portfolio in the coming years, including future developments (future perspectives);
- Customs Central Applications – Architectural aspects;
- IT statistics.

9.1. THE BUSINESS ENVIRONMENT

9.1.1. POLICY UNITS

They are responsible for the policy management and related business process models. They are the main “customers” of Units R5 and A3. The policy units may also be “users” of specific systems that they need to fulfil their mandate (e.g. Tariff Applications).

The organisation chart of DG TAXUD can be found on the EUROPA website. This organisation chart is subject to change:

http://ec.europa.eu/taxation_customs/common/about/structure/index_en.htm

9.1.2. NATIONAL ADMINISTRATIONS (NAS)

The **national administrations**, national project and operation teams, are responsible for the deployment and operation of the national components (national Configuration Items including national applications) of the trans-European systems. The term national administrations encompasses all national administrations which have IT obligations to fulfil EU customs and taxation policies, in all Member States, Candidate and Accession Countries and in third countries, arising from EU customs and taxation policies.

9.1.3. MANAGEMENT COMMITTEES

The **Management Committees**: delegates from the national administrations, EFTA countries, neighbouring countries (Ukraine, for example) and from other third countries (China, Russia, etc.), as appropriate, and the Commission compose these Committees set up by the legal bases.

¹³ See http://ec.europa.eu/taxation_customs/common/tenders_grants/tenders/index_en.htm.

9.1.4. WORKING GROUPS / PARTIES AND ECONOMIC OPERATORS

The Working Groups / Parties or Technical Sub-Committees are set up by the Management Committees as needed with specific mandates. The Working Groups / Parties or the Technical Sub-Committees report to their respective Management Committees.

On the other side, **Economic operators** are fast increasing user/consumer base of the IT services provided by DG TAXUD via its presence on the EUROPA site. They are also users of the national administrations interconnected via TES.

9.1.5. INTERACTIONS WITH NAS, BUSINESS UNITS AND OTHER PARTIES IN THE EUROPEAN COMMISSION

The R5 unit is responsible for the overall coordination with the MS and the business units for business and matters related to architecture, strategy and customs IT systems and applications, while Unit A3 is responsible for any matter related to the customs business processes.

9.2. ARCHITECTURE AND STRATEGY BACKGROUND

9.2.1. IT STRATEGY & IT MASTER PLAN

The business objectives relevant for IT in the area of Customs Union, concern the implementation of Union Customs Code (UCC) and eCustoms legislations, extended with the Safety and Security policy.

In this framework, the IT Strategy pursues to implement the Customs Union business objectives whilst reducing to the minimum extent the overall IT investment necessary in the Union, cutting down costs necessary for trade and for the Member States. In parallel, the aim of the IT strategy is to gradually achieve convergence in customs IT at the EU level by adopting certain practices so as to streamline customs IT operation and improve the quality of services.

The cornerstones of the IT strategy are the following:

- The future IT systems shall be designed and implemented using a service-oriented architecture, so as to favour the emergence of flexible, modular, easy to change IT systems that benefit from the re-use of existing functionality in another Member State or in the Commission. By adopting a service-oriented approach in the design of new systems, as advocated in the European Interoperability Framework (EIF¹⁴), we aim at producing modular IT systems that can re-use some pieces of software developed in collaboration.
- A new generation of CCN, called "CCN2", shall be implemented as the interoperability infrastructure which enables the new architecture. By adopting the renovation of CCN, we create in CCN2 an interoperability infrastructure which offers access to services independently of their location and backwards compatible with existing customs systems.
- Where appropriate EIS could be implemented centrally, in view of total cost reduction and subject to a positive business case. For example, in the case of the customs decisions project, the Commission could develop the national domain functionality and the single access point for trade and make them accessible at the appropriate level

¹⁴ http://ec.europa.eu/isa/documents/isa_annex_ii_eif_en.pdf

of availability and performance. Such approach could provide for the Customs Decisions project, savings in the range of 40 to 50 Million € in the EU. In this case, the Member States (MS) would capture the benefits whilst doubling or tripling the cost and effort necessary at the Commission. In order to achieve this objective, DG TAXUD has embarked in the creation of high availability IT infrastructure offering appropriate service levels. However, practice showed in the customs decision project that such central implementation is not welcome by all MS, for various reasons. Per example, MS argued that they have also other national decisions to manage and they wish to do so by a single system. This drives the need for the design of modular systems, which allow to plug in national systems the related functionality using the service-oriented architecture capability, whilst at the same time foreseeing specific interfaces for the MS that wish to develop their IT system in full. This hybrid architecture is of course more complex to design and implement by the Commission than in the case of a single central functionality and is less agile to change.

- Collaboration between willing customs national administrations in the design and (if possible) implementation of future systems shall be favoured, so as to avoid repetition and reduce redundancy of effort and total cost in the European Union. Collaboration neither drives to identical systems nor it is considered possible to create a single customs system.
- A reference architecture (enterprise architecture) for Customs IT shall be developed so as to build a common language and planning basis for future systems. A pilot project explores the feasibility of such collaboration in 2012.
- Future systems should offer a single access point for trade, hence, reducing the number of connections of trade to the customs union from 27 to 1: by addressing future trader access systems related to declarations using the above practices and techniques, we could reduce the trade costs significantly. Moreover, such interface could also be hosted at the Commission, hence, reducing de facto the interfaces to trade to one. It is well understood that this delicate matter will be subject to further discussions based on the result of specific feasibility studies and business case analysis generating the necessary level of trust and detailed understanding on a case by case basis.
- If there would be a shift of responsibilities from MS to the Commission following agreements reached at strategic level and reflected in the appropriate legal frameworks, then adequate resources will need to be available to guarantee a correct implementation (also additional human resources would be provided from the Member States using virtual teams and internet collaboration, to employ these resources from their usual assignment and living place, in order to ensure that national requirements are implemented effectively). The Commission has included provisions to support the above strategy in its proposal establishing an action programme for customs in the European Union for the period 2014-2020 (CUSTOMS 2020). This proposal is currently under discussion at Council and Parliament.

The IT Strategy was defined via a consultation process with the Member States along three parallel activities related to the above principles:

- The definition of an IT Master Plan over the next ten years including costs and effort estimations for the implementation of UCC and eCustoms legislations, extended with the Safety and Security policy. The IT Master plan was an essential input and component for the Multi-Annual Strategic Plan (MASP) maintained by TAXUD unit A3, which has been formally adopted in December 2012.

- The realisation of a Reference Architecture for eCustoms comprised at this stage of a Reference Enterprise Model and a Reference Service Architecture.
- Support to collaboration initiatives between Member States.

The findings and conclusions of the above activities together with a description of the IT Strategy were consolidated in the IT Master Plan Study Report.

In average and in relation to the above activities (IT Strategy, IT Master Plan, IT Architecture or Collaboration projects), during 2011 and 2012, the development contractor has assisted monthly either to bilateral meetings or workshops in Member States premises; assisted weekly or biweekly technical meetings with TAXUD staff; provided quarterly major deliverables or major updates and provided monthly minor updates of these deliverables.

The ARIS tool has been extensively used in the context of the aforementioned works; within the mentioned deliverables approximately 500 ARIS models of various complexities have been realised of which about 220 for the realisation of the Reference Architecture and 280 for support to collaboration.

9.2.2. IT CUSTOMS ARCHITECTURE

When considering the EU customs systems architectures, a distinction should be made between the EU wide viewpoint where the whole European customs is considered and the more concrete viewpoint of those systems of which TAXUD is responsible for in terms of IT operations.

The EU wide viewpoint can only take the form of a Reference Architecture with the objective of defining a common language, enabling collaboration between the many stakeholders and facilitating interoperability between all EU customs systems.

An initial Reference Architecture was realised during 2011 in cooperation with 9 Member States and took shape using two main viewpoints:

- The *Reference Enterprise Model* consisting of an architectural landscape depicting the EU Customs Business and allowing the mapping of business or IT initiatives against the business capabilities and data entities. This model also provides a logical view of the solution building blocks for the entire customs business.
- The *Reference Service Model* providing a framework for the architecting of a customs systems logical services repository in view of the application of a SOA approach and the enabling of Member States collaboration and sharing.

The IT Customs Reference Architecture is today still under development and requires further effort to become a recognised and accepted instrument for the strategic evolution of EU Customs in the benefit of all its stakeholders.

The diagrams and models of the IT Customs Reference Architecture have been realised within the ARIS tool with the objective of maximising the alignment with the UCC Business Process Models.

The challenges facing the architecture activity in TAXUD lie today in the consolidation and alignment of the different architectural descriptions and in making them an efficient instrument in support of the governance and implementation of the EU customs IT systems according to the business objectives and along a well-defined and agreed IT Strategy.

9.2.3. EU CUSTOMS IT COLLABORATION

Collaboration between Customs Stakeholders and especially between the Member States is an essential part of the IT Strategy as the driver for IT cost reductions.

In view of the interest of Member States in exploring the collaboration a working group was organised for the exploration of this kind of activities. The group was defined with the objective of realising shared specifications in the context of the Customs Core processes mainly involving movement of goods and/or Declaration Management for Customs procedures.

The foreseen difficulties and unknowns lead to the decision by the group to start with a more limited scope realised by a reduced number of Member States, and so was launched the Customs Warehousing Collaboration Pilot project (CWCP). This project group will explore the realisation of reusable functional and technical specification for a Customs Warehousing system (mainly focused on the declaration managements).

The CWCP project is under the responsibility of three Member States in equal grounds and has the support of DG TAXUD for technical assistance and support for coordination.

The CWCP project deliverables make extensive use of the ARIS platform where at least 70% of the functional and technical specifications are registered.

9.3.CUSTOMS BUSINESS ANALYSIS AND MODELLING BACKGROUND

In order to support the mission of customs authorities in the EU, the Commission and the Member States have identified the need to set up and operate secure, integrated, interoperable and accessible customs computerised systems (also referred to as EIS). Their goal is mainly to facilitate customs processes for the movement of goods into and out of the European Union, and to reduce the risks of threats to the safety and security of citizens by minimising the remaining differences between Member States' customs processes. The EIS will in general be built according to international standards¹⁵, thus allowing future interaction with 3rd countries' systems.

As stated in article 2§1 of the eCustoms decision¹⁶, the Commission and the Member States will aim to provide the structure and means by which the Commission, customs administrations and other border agencies in the EU can exchange electronic information in order to:

- control and facilitate the movement of goods into and out of the internal market through efficient import and export procedures;
- increase the competitiveness of European trade through a reduction of compliance and administrative costs and an improvement in clearance times;

¹⁵ The international standards used are for instance the WCO data model, ISO and UN norms where applicable, and other standards like International Maritime Organization (IMO), number or European Vessel Identification (ENI), IATA/ICAO flight numbers, IATA structure of numbers of ULD containers.

¹⁶ Decision No 70/2008/EC of the European Parliament and of the Council of 15 January 2008 on a paperless customs environment for customs and trade, OJ 2008, N° L23, p 21.

- facilitate legitimate trade through a coordinated approach relating to the control of goods;
- improve the safety and security of citizens with regard to dangerous and illicit goods;
- offer improved protection of the financial interests of the European Union and its Member States;
- contribute to the fight against international crime and terrorism by providing rapid and relevant information with regard to the international supply chain;
- allow for a seamless flow of data between the authorities of exporting and importing countries on the basis of Regulation (EC) 648/2005 and new legislation to be implemented.

The objectives set out in this Section will be achieved by at least the following means (first 3 bullet point are defined in article 2§2 of the eCustoms decision¹⁷) :

- the harmonised exchange of information on the basis of internationally accepted data models and message formats;
- the re-engineering of customs and customs-related processes with a view to optimising their efficiency and effectiveness, to their simplification and to reducing the costs of customs compliance;
- the offering to economic operators of a wide range of electronic customs services enabling those operators to interact in the same way with the customs authorities of any Member State;
- the appropriate legal framework to enable the achievement of these objectives.

Furthermore, the Regulation (EC) No 450/2008 of the European Parliament and of the Council of 23 April 2008 laying down the Customs Code (Modernised Customs Code- MCC)¹⁸ aimed at the **adaptation of customs legislation in order to**

- fit, but also to govern, the electronic environment for customs and trade; and
- carry out a major overhaul of the customs rules in order to make them simpler and better structured.

Following technical and procedural considerations, the Commission found it appropriate to proceed to a recast of this Regulation whilst retaining the main policy objectives of the MCC.

The present proposal on the UCC (MCC Recast) must be seen in the context of:

- a) the modernisation of customs legislation and procedures and the use of IT systems for customs clearance and procedures in view of facilitating the way of doing business with customs and ensuring safe and secure trade of goods in the European Union;

¹⁷ Decision No 70/2008/EC of the European Parliament and of the Council of 15 January 2008 on a paperless customs environment for customs and trade, OJ 2008, N° L23, p 21.

¹⁸ OJ L 145, 4.6.2008, p.1.

- b) the requirements of the Treaty of Lisbon;
- c) the evolution of policies and legislation in other fields that might impact customs legislation such as safety and security in the transport field;
- d) the evolution of business processes that require clarity and coherence in the customs rules.

Besides, in order to allow administrations and economic operators adequate time to undertake the necessary investments and ensure a phased, binding but realistic implementation of electronic processes, the Commission will continue to work with all stakeholders with a view to ensuring that the new electronic processing environment will be operational by the date established in the customs legislation.

9.4. THE PORTFOLIO OF CUSTOMS IT SYSTEMS AND APPLICATIONS

9.4.1. PORTFOLIO OVERVIEW

Table 1 below provides the entries of the portfolio of the customs IT systems and applications (March 2013). The table has to be read as Configuration Items (CIs) to be managed in a CMDB. These CIs are in line with the CMDB entries managed by the ITSM contractor.

General information on customs IT systems and applications may be found on the Europa web site:

http://ec.europa.eu/taxation_customs/customs/policy_issues/electronic_customs_initiative/it_projects/index_en.htm

The portfolio is organised by families as follows:

- **Movement systems and supporting applications:** includes the distributed movement systems NCTS, ECS and ICS together with its supporting applications operated centrally;
- **Internal Applications:** includes applications that are used by commission staff to manage the publications (e.g. the Combined Nomenclature), the budget and other deliverables;
- **Risk Analysis and Control Applications:** includes applications that are used in the domain of risk analysis and control;
- **Internet Applications:** is mainly represented by the unique application (DDS2) that permits citizens to consult public information retrieved from other systems and applications;
- **Economic Operators Applications:** includes the applications managing information associated with economic operators;
- **Tariff and Classification:** includes the applications managing customs information concerning goods and more specifically tariff and classification information;
- **TATAF:** include the technical components which are deployed on a more horizontal level and which are part of the Tariff Application Technical Architecture Framework;
- **SPEED2:** includes software components constituting the Single Portal for Entry and Exit of Data (SPEED).

ID	IT system/application (CI)	Acronym	IT system/application family
1	New Computerised Transit System (NCTS)	NCTS	Movement systems and supporting applications
2	Export Control System (ECS)	ECS	Movement systems and supporting applications
3	Import Control System (ICS)	ICS	Movement systems and supporting applications
4	Central System for Reference data (CS/RD)	CS/RD	Movement systems and supporting applications
5	Central System MIS (CS/MIS)	CS/MIS	Movement systems and supporting applications
6	Standard Transit Test Application (STTA)	STTA	Movement systems and supporting applications
7	Transit Test Application (TTA)	TTA	Movement systems and supporting applications
8	SPEED-ECN (SPEED-ECN)	SPEED-ECN	Movement systems and supporting applications
9	Standard SPEED Test Application (SSTA)	SSTA	Movement systems and supporting applications
10	Activity Reporting Tool (ART-2)	ART2	Internal
11	Combined Nomenclature (CN)	CN	Internal
12	Suspensions (SUSP)	Suspensions	Internal
13	Community Risk Management System (CRMS)	CRMS	Risk Analysis and Control
14	anti-COUNTERFEIT and anti-PIRACY Information System (COPIS)	COPIS	Risk Analysis and Control
15	Specimen Management System (SMS)	SMS	Risk Analysis and Control
16	DDS2-CM	DDS2-CM	Internet
17	DDS2-COL	DDS2-COL	Internet
18	DDS2-EBTI	DDS2-EBTI	Internet
19	DDS2-EOS	DDS2-EOS	Internet
19	DDS2-ECICS	DDS2-ECICS	Internet

20	DDS2-EXPORT	DDS2-EXPORT-MRN	Internet
21	DDS2-SEED	DDS2-SEED	Internet
22	DDS2-SURV	DDS2-SURV	Internet
23	DDS2-SUSP	DDS2-SUSP	Internet
24	DDS2-TARIC	DDS2-TARIC	Internet
25	DDS2-TRANSIT	DDS2-TRANSIT-MRN	Internet
27	Economic Operators System (EOS)	EOS	Economic Operators
28	Economic Operators System (EOS-MRA)	EOS MRA	Economic Operators
29	Regular Shipping Service (RSS)	RSS	Economic Operators
30	European Binding Tariff Information (EBTI-3)	EBTI3	Tariff and Classification
31	European Customs Inventory of Chemical Substances (ECICS-2)	ECICS2	Tariff and Classification
32	Information System for Processing Procedures (ISPP)	ISPP	Tariff and Classification
33	Quota Management (Quota-2)	Quota2	Tariff and Classification
34	Surveillance management and monitoring (Surveillance-2)	SURV2	Tariff and Classification
35	TARif Intégré Communautaire (TARIC-3)	TARIC3	Tariff and Classification
36	CSI Bridge	CSI Bridge	TATAF
37	HTTP Bridge	HTTP Bridge	TATAF
38	User management (UM)	UM	TATAF
39	SPEED2	SPEED2	SPEED2

Table 1: Portfolio of customs IT systems and applications

9.4.2. NCTS

9.4.2.1. BUSINESS DESCRIPTION

The NCTS is the New Computerised Transit System, based upon electronic declaration and processing, and designed to provide better management and control of EU and Common Transit. It involves all EU Member States, the EFTA countries, Andorra, San Marino, Croatia and Turkey. More countries will be joining in the future.

NCTS has most likely made the largest contribution to trade facilitation by simplifying and speeding up the transit procedure for both traders and administrations. NCTS allows traders to submit their declarations before departure, so waiting time at the borders is considerably reduced. In addition, the use of electronic messages instead of paper documents enables an earlier end and discharge of the operations. This leads directly to the faster release of the guarantee lodged. Further time gains are achieved when considering physical controls on goods. As customs will have decided well in advance whether or not the goods need to be subject to a control, waiting time at the office of destination is shortened. Finally, as NCTS creates an electronic environment capable of directly managing all the movements of goods, formalities for Authorised Consignors and Consignees have become much less cumbersome. Also, any discrepancies can be sorted out more quickly in the electronic enquiry procedure. All these features lead to an overall reduction of (administrative) costs and burdens for businesses.

The customs authorities of the Member States control each year **10 million trucks** carrying non-EU goods transiting via the Union in real-time customs control (from departure to arrival and clearance) through almost **50 million electronic information exchanges** sent through the New Computerised Transit System (NCTS).

Since 1 July 2009 NCTS includes the electronic handling of transit declarations under the security amendment Regulation 648/2005 which requires additional information to be included in transit declarations for safety and security purposes. The features implemented on 1 July 2009 allow to:

- upgrade the enquiry procedure which can be initiated when either the time allotted for receipt of transit movement arrival at destination, or the time for receipt of the control results from the Office of Destination has expired;
- introduce the recovery procedure which usually starts as a follow up to the Enquiry Procedure but it can also be initiated in any state after the movement release in specific cases like when a Customs Officer in the Competent Authority suspects that a fraud or another abnormal incident took place;
- transmission of information on movements of sensitive goods to OLAF (Anti-Fraud Transit Information System – ATIS) (including the National transit).

Since 1 September 2011 all EU transit declarations are also duplicated and sent to OLAF (also for Common transit declarations, except for Switzerland, Croatia and Turkey).

The NCTS is continuously expanding from a geographical point of view, with more countries becoming members of the Common Transit Convention in the coming years.

On 01/01/2009, an electronic connection was launched with Russia to allow for secure data exchange of TIR movement data, in order to address lorry congestion at the EU-Russia border (currently 3,500 movements supported daily). This connection has been established through the SPEED platform (using CCN/CSI) on which SPEED-ECN application is running in order to transfer NCTS message to SPEED message.

9.4.2.2. OPERATIONAL INFORMATION

Currently, there are 34 countries (national administrations) interacting with NCTS which supports on average 205,000 movements and 1,100,000 messages per week. The number of released international movements (IE001) recorded for NCTS by the end of November 2012 (since April 2002) was 78.5 Mio with a daily average of about 37,100 movements for business days. The average error rate in November 2012 was 0.17%.

Some key NCTS indicators from the years 2001 to November 2012 are shown below.

Information per year	2001	2002	2003	2004	2005	2006	2007	2008	2009	2010	2011	up to 30/11/2012	All
Movements (IE001)	4,931	117,894	1,103,057	5,507,064	7,582,264	8,353,265	8,657,387	8,755,333	8,814,395	9,836,609	10,344,076	9,421,013	78,497,288
Errors (IE906 +IE907)	1,417	15,026	77,821	323,627	244,232	208,746	131,024	118,389	332,704	157,140	142,238	76,099	1,828,463
Total Messages	32,889	892,025	6,808,563	27,620,279	40,223,343	40,655,411	41,887,717	42,528,753	42,408,883	46,499,304	51,857,441	52,693,278	394,107,886
Error Rate (% of all messages)	4.31%	1.68%	1.14%	1.17%	0.61%	0.51%	0.31%	0.28%	0.78%	0.34%	0.27%	0.14%	0.46%
Average movements per working day	19	453	4,243	21,181	29,163	32,128	33,298	33,674	33,902	37,833	39,785	39,254	25,322

Table 2: NCTS - Key indicators per year

In addition, the volume of movements and errors for the same period (2001 – 2012) is shown in the following figure.

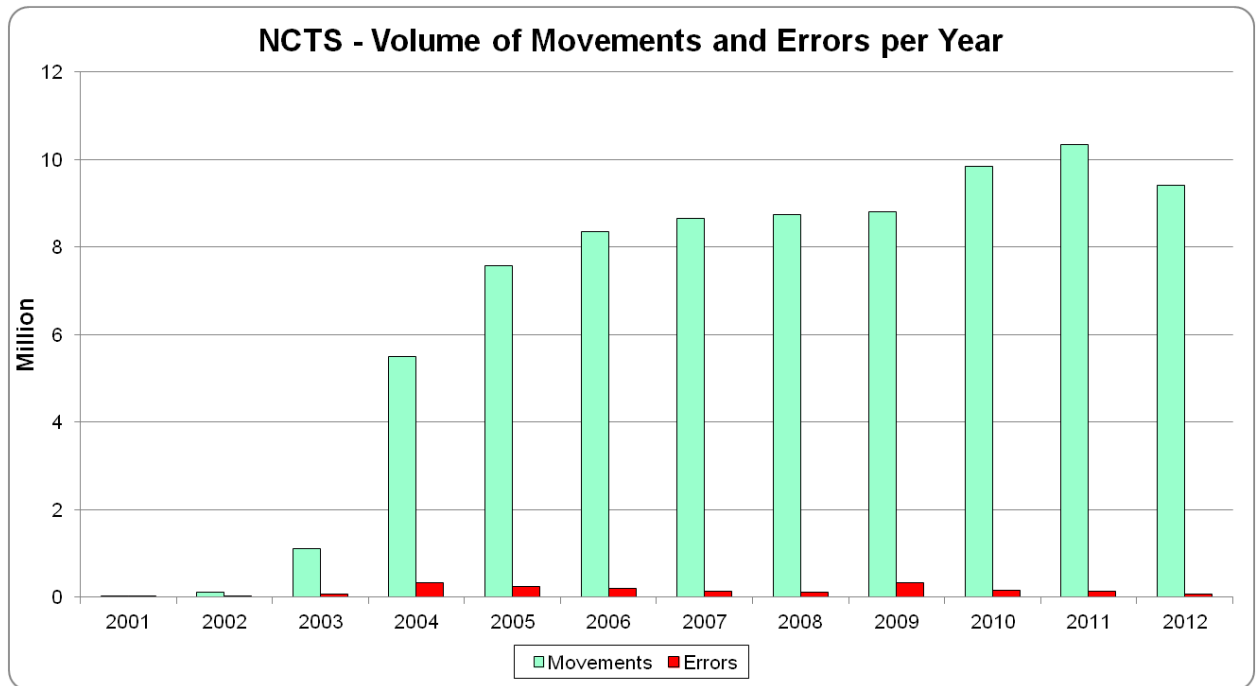

Figure 5: NCTS volume of movements per year

NCTS is monitored on a daily basis, and 1 to 3 incidents are created for investigation by national administrations. Please refer to section 9.7 for more information on the volume of incidents open per system. The number of movements is expected to further increase after 01/12/2012 when Turkey joined the Convention for Common Transit.

9.4.3. ECS

9.4.3.1. BUSINESS DESCRIPTION

System to manage electronically the indirect export procedure.

During the Customs 2002 seminar in Vuokatti (December 2002) the Commission, the EU-Member States and the Candidate Countries proposed to set up an Export Control Pilot Project (EPP).

ECS, the forerunner of the **Automated Export System (AES)**, ensures the electronic handling of the export procedure.

ECS Phase 1 applied to the movement of goods released for export and moving as one consignment, exported via another Member State (MS). Since 01 July 2009, ECS Phase 2.0 is applied to satisfy the requirements stipulated in the so-called "security amendment" to the Customs Code (Regulation (EC) No 648/2005).

9.4.3.2. OPERATIONAL INFORMATION

Currently, there are 27 countries (national administrations) interacting with ECS which supports on average 270,000 movements and 750,000 messages per week. The number of released movements (IE501) recorded in ECS for the third quarter 2012 was 3.25 Mio.

Some key ECS indicators from the years 2007 to 2012 are shown below.

Information per year	2007	2008	2009	2010	2011	up to 01/12/2012	Total
Movements (IE501)	1,951,089	4,712,823	7,115,876	10,886,664	12,125,015	11,948,227	48,739,694
Errors (IE906 +IE907)	221,740	168,439	556,367	307,227	263,201	144,936	1,661,910
Total Messages	5,189,194	13,236,290	20,873,568	30,008,497	33,291,926	32,635,582	135,235,057
Error Rate (% of all messages)	4.27%	1.27%	2.67%	1.02%	0.79%	0.44%	10.47%
Average movements per working day	7,504	18,126	27,369	41,872	46,635	49,784	31,649

Table 3: ECS - Key indicators per year

In November 2012, the volume was stable at about 52,000 movements per business day, while the average error rate was reduced to 0.34% (from 0.57% at the end of 2011), as illustrated on the figure below.

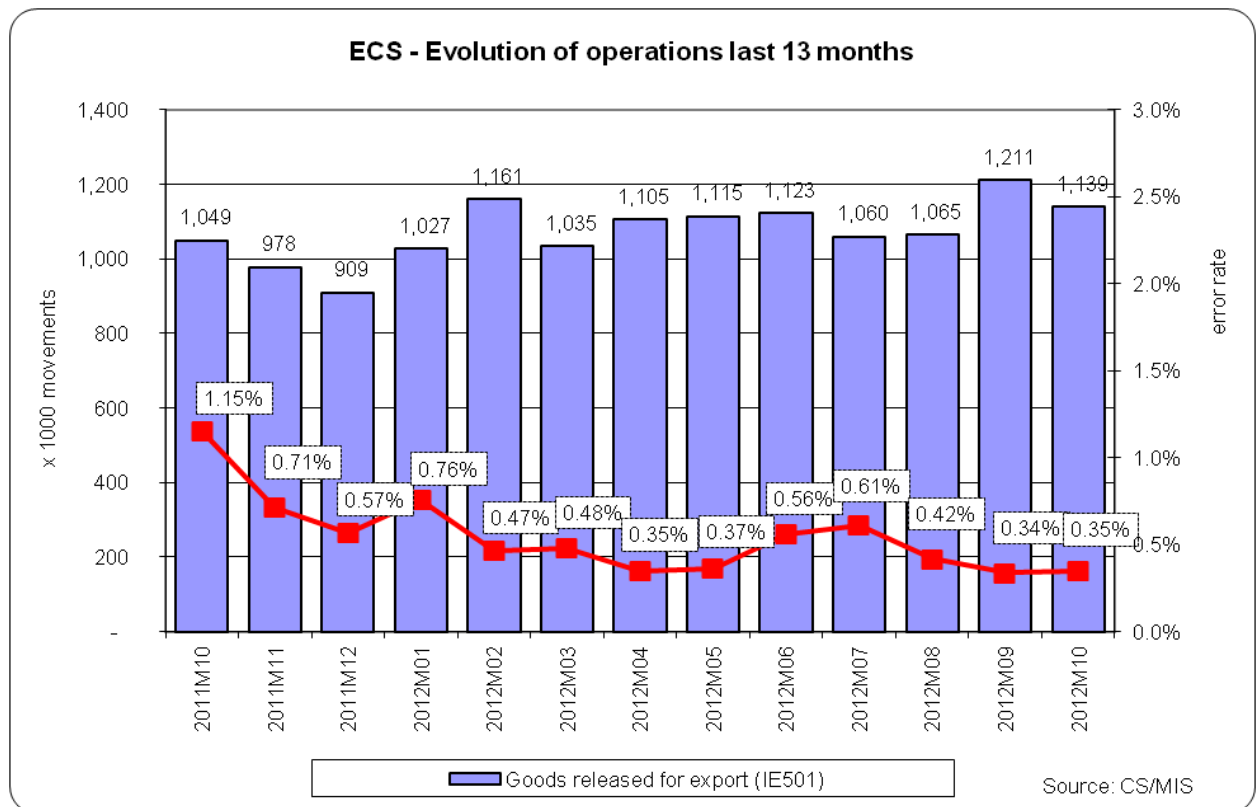

Figure 6: ECS evolution of operations

The system is monitored on a daily basis, and 3 to 5 incidents are created for investigation by national administrations. Please refer to section 9.7.7 for more information on the volume of incidents open per system. The number of movements is expected to increase after 01/07/2013 with the accession of Croatia.

9.4.4. ICS

9.4.4.1. BUSINESS DESCRIPTION

A system to manage electronically some aspects of the import procedure; it will evolve towards the full Automated Import System (AIS).

The ICS is the result of AIS phase 1, and as such is the first step towards the implementation of a full-blown AIS (Automated Import System). ICS strictly includes what is needed to implement Regulation 648/2005 and its Implementing Provisions (Regulation 1875/2006), and provides a solution to the processing of the Entry Summary Declaration (ENS) at:

- the Office of Lodgement;
- the Office of First Entry (including international diversion);
- any Office of Subsequent Entry, whether or not declared in the ENS.

9.4.4.2. OPERATIONAL INFORMATION

The main operational data of this system is summarised below.

Information per year	2011	Up to 30/11/2012	Total
Total ENS lodged by traders	34,381,039	38,949,163	73,330,202
Total messages on the Common Domain	1,513,692	4,881,902	6,395,594
Total ENS lodged by traders	171,555	107,322	278,877
Total messages on the Common Domain	11.33%	2.20%	4.36%

Table 4: ICS - Messages and errors per year

9.4.5. CS/RD

9.4.5.1. BUSINESS DESCRIPTION

CS/RD is a supporting application to the movement systems managed by DG TAXUD R5/APM. This application is critical and supports the trans-European systems already in place between the National Administrations. It offers a central repository for reference data. Reference data means the common reference data (e.g. Country code list, Document type Codelist), but also the Customs Offices and the Sharing Authorities. Each National Administration is responsible for providing and maintaining its Customs Office List in this central database. The CS/RD data are covering various domains: NCTS, ECS, ICS, EOS, COPIS.

9.4.5.2. OPERATIONAL INFORMATION

Number of users (Approx) : about 200 – not all are active

Number of messages/Year (Approx) : less than 20.000

Order of magnitude of DB Size : 500MB

9.4.6. CS/MIS

9.4.6.1. BUSINESS DESCRIPTION

A Central Application which collects the traces of the messages exchanged on the Common Domain, generates statistics and reports, collect the business statistics and the availability details of the National Applications for NCTS, ECS, ICS and SPEED-NCTS TIR Russia.

The CS/MIS application is used by the Commission and National Administrations and provides them with the facilities needed to monitor and report on the operations of the Central and National NCTS, ECS, ICS and SPEED systems. This is done by collecting and distributing business statistics, technical statistics and information on the availability of NCTS, ECS, ICS and SPEED and/or National Systems.

9.4.6.2. OPERATIONAL INFORMATION

Number of users (Approx) : about 200

Number of messages/Year (Approx) : About 13 million (99.95 % are audits & stats files)

Order of magnitude of DB Size : 500GB

9.4.7. STTA

9.4.7.1. BUSINESS DESCRIPTION

STTA is an application developed by DG TAXUD and used locally by the National Administrations to perform Mode 1 tests before they perform Conformance Testing (mode 2). Mode 1 tests insure the compliance of messages sent/received by National Application with the NCTS, ECS, ICS specifications (for the interfaces with the Common Domain and the External Domain).

9.4.7.2. OPERATIONAL INFORMATION

Once validated, STTA is published on the CIRCA (CIRCABC) platform. From that moment National Administrations are free to download and install it on their side. No control is done neither on the number of execution nor on the number of messages processed by the installed instances of STTA.

Usually two releases in December and June are provided to the National Administrations for performing the Conformance Testing.

Approximately 100 National Administrations use the application, though they are not all are active at the same time.

9.4.8. TTA

9.4.8.1. BUSINESS DESCRIPTION

TTA is a central testing application that must be used by the National Administrations for performing Conformance Testing (mode 2). The Transit Test Application (TTA) provides a means to test a National Application (National Transit Application, National Export Control Application, National Import Control Application) by using scenarios in order to check common domain electronic message exchanges through through CCN/CSI gateways.

9.4.8.2. OPERATIONAL INFORMATION

TTA is used by 32 NCTS National Project Teams, 27 ECS National Project Teams and 27 ICS National Project Teams. Two releases are provided annually in December and June in order for to the National Administrations to perform conformance tests.

TTA must be able to process all scenarios included in the three CTP databases to test both three domains NCTS 271 scenarios exchanging 40 different messages, ECS 114 scenarios exchanging 17 different messages, and ICS 97 scenarios exchanging 6 different messages.

9.4.9. SPEED-ECN

9.4.9.1. BUSINESS DESCRIPTION

SPEED-ECN is the SPEED component that ensure the secured exchange of messages between the Commission (14 Member States participating) and the third countries (Russia for example) with which the EU has on-going international cooperation. The SPEED-ECN component currently only supports the exchanges of pre-arrival customs NCTS-TIR information.

The need for information exchange is coming either from operational difficulties to perform customs controls in a time frame which responds to expectations from economic operators; or from requirements to achieve secure and safe trade lanes. Indeed the Regulation 1875/2006 introduces such measures from 01/07/2009 onwards in the EU and several of our trading partners have similar measures or plans to introduce such measures.

SPEED-ECN is converting the EDIFACT messages IE012 received from the Member States' application, to produce an XML message (IES01) sent to the Russia application via CCN/CSI.

9.4.9.2. OPERATIONAL INFORMATION

The main operational data of this system is summarised below. It must be noted that the system is still considered as a pilot from a business perspective.

Information per year	2009	2010	2011	Up to 30/11/2012	Total
Movements (IE012)	558.032	961.823	1.088.248	1.101.833	3.709.936
Errors (IE907 +IE917)	6.477	2.177	261	323	9.238
Error Rate (% of all messages)	1.16%	0.23%	0.02%	0.03%	0.25%
Average movements per working day	2.146	3.699	4.186	4.591	3.,637

Table 5: NCTS-RU - Messages and movements volumes per year since start in 2009

9.4.10. SSTA

9.4.10.1. BUSINESS DESCRIPTION

The Standard SPEED Test Application (SSTA) is a centrally developed test application that supports NCTS and SPEED.

SSTA offers the NA a light PC application to execute, in a cost effective manner, the mandatory National (Mode 1) Tests before applying for conformance Testing (Mode 2). Mode 1 tests assure the compliance of the NTA with the SPEED specifications for the interface with the Common Domain and the External Domain.

9.4.10.2. OPERATIONAL INFORMATION

9.4.11. ART2

9.4.11.1. BUSINESS DESCRIPTION

The Activity Reporting Tool (ART2) supports the management of the large number of joint action activities under the Customs 2013 and Fiscalis 2013 Programmes (the Programmes) supporting the functioning of the Customs Union and taxation systems in Europe.

ART2 enables the decentralised implementation of the Programmes, where the stakeholders of the programme, national customs and tax administrations, implement the Programmes managed and led by the Commission. The application covers the full lifecycle of programme management from proposal management and action/event management up to participant management, monitoring and evaluation. ART2 accommodates the specific implementation structures of the Programmes and serves as a single point of reference for all stakeholders situated in the Commission and in the Member States.

Each activity under the Programmes needs to be initiated via ART2. Stakeholders can follow the approval procedure through ART and may be consulted when appropriate. All event (meeting) and participant information is connected to the approved activities. The action fiche describes the background and context, the set objectives and expected results as well as the link to the Annual Work Programme. It also identifies the specific area within customs and taxation to which the activity relates. The programme managers in Member States manage their participation in the different programme events through ART2 and register participants for events through ART2.

Member States also use the system to enter financial data related to the costs reimbursed to participants or for the organisation of programme events. The on-time availability of financial data allows the Commission to assess the financial state-of-play at any given time. ART2 is used as the official reporting tool on expenditures carried out by the Member States and is recognised as the means of providing financial information for the annual closure of pre-financing assigned to the Member States in the form of grants. The validation rules provide the Commission with the power of budgetary and management control.

The data in ART are essential for the monitoring and evaluation of the Programmes and their impact. The system provides search functions and preset queries that support the filtering of information according to the specific/targeted needs.

9.4.11.2. OPERATIONAL INFORMATION

The current size of the ART2 database is 10 GB. There are approximately 1000 events per year and 15000 participants per year.

9.4.12. CN

9.4.12.1. BUSINESS DESCRIPTION

CN is a system to draw up and publish the Combined Nomenclature for tariff classification and statistical purposes.

In order to monitor the flow of goods into and out of the European Union, the goods are identified with reference to a nomenclature for tariff and statistical purposes, the Combined Nomenclature. The CN consists of a table of goods descriptions with related codes together with rules and notes for its interpretation.

In the past, the CN regulation and the CN Explanatory Notes (CNENs) were prepared manually on paper, i.e. without any kind of electronic support (+/- 1000 pages in each official language for the CN). The CN management system supports the publication process of the CN regulation from 2005 onwards (for the publication applicable on 1/1/2006) and solves potential inconsistencies between linguistic versions.

As it is possible to provide the Publications Office with the manuscript in electronic form, the system also helps reducing delays in the publication process.

9.4.12.2. OPERATIONAL INFORMATION

Number of users: approximately 3 DG TAXUD internal users (internal application).

Order of magnitude of DB Table Space Size:

- Production environment: 7 GB;
- Conformance environment: 7GB;
- Test environment (PSAT or SAT): 2 GB;
- Performance test environment (if required): 2 GB.

Disk Space:

- CN application source archive (needed during installation): 200 MB
- CN runtime archive building (needed during installation): 200 MB + 100 MB in /tmp.
- CN application runtime environment (needed during installation and operation): 100 MB

9.4.13. SUSP

9.4.13.1. BUSINESS DESCRIPTION

Allows the creation of a dossier on the suspension of import duties for certain goods; constitutes a back-up to the publication of suspension regulations in the Official Journal.

The suspensions system supports the legislative work for regulations covering the following measures:

- temporarily suspending the autonomous Common Customs Tariff duties on certain industrial, agricultural and fishery products;
- temporarily suspending the autonomous Common Customs Tariff duties on a number of products intended for the construction, maintenance and repair of aircraft;
- autonomous EU Tariff quotas for certain agricultural and industrial products.

For the autonomous suspensions and quotas there are usually 2 publication cycles or rounds started per year, although this is not a fixed rule.

9.4.13.2. OPERATIONAL INFORMATION

The business unit manages about 1.200 suspension dossiers and about 100 quota dossiers.

Regulations are published twice a year after a proposal/decision cycle which takes about 9 months.

Number of users: ca. 3 DG TAXUD internal users (internal application).

Order of magnitude of DB Table Space Size:

- Production environment: 80 GB;
- Conformance environment: 80 GB;
- Test environment (PSAT or SAT): 2 GB;

Disk Space:

- Suspensions application source archive (needed during installation): 200 MB;
- Suspensions runtime archive building (needed during installation): 300 MB + 100 MB in /tmp;
- Suspensions application runtime environment (needed during installation and operation): 150 MB.

9.4.14. CRMS

9.4.14.1. BUSINESS DESCRIPTION

The latest amendments to the Customs Code (Council Regulation 648/05) and its Implementing Provisions (Commission Regulation 1875/06, CCIP) introduced a legal basis for the establishment of the Risk Management Framework which shall be implemented through an electronic Community (Customs) Risk Management System (CRMS). CRMS includes three essential elements for which an electronic solution has to be or has already been developed:

- Exchange of risk information (RIF system already operational);
- EU (Customs) Priority Control Areas and Common Risk Criteria (in operation since September 2009);
- Comprehensive set of security risk rules to be used for continuous screening of electronic entry and exit summary declarations for the security and safety purpose (not yet developed).

9.4.14.2. OPERATIONAL INFORMATION

More than 5000 users are connected to CRMS. The number of RIFs created per year is approximately 2.000. The database contains currently more than 7.000 RIFs.

Order of magnitude of DB Table Space Size:

- Production environment: 100 GB;
- Conformance environment: 100 GB;
- Test environment (PSAT or SAT): 600 MB;
- Performance test environment: 10 GB.

Disk Space:

- CRMS application source archive (needed during installation): 200 MB;
- CRMS runtime archive building (needed during installation): 300 MB + 100 MB in /tmp;
- CRMS application runtime environment (needed during installation and operation): 100 MB;
- CRMS performance test files: 40 GB max.

9.4.15. COPIS

9.4.15.1. BUSINESS DESCRIPTION

COPIS is a system to exchange Applications for Action to protect goods subject to intellectual property rights against counterfeiting and piracy.

The purpose of the anti-COunterfeit and anti-Piracy Information System (COPIS) is to protect the Intellectual Property Rights as set down in the Council Regulation (EC) No 1383/2003 and Commission Regulation (EC) No 1891/2004. To protect themselves from counterfeiting and piracy, right holders can ask the intervention of Customs in order to take measures against goods infringing certain intellectual property rights at the border. COPIS will simplify and reduce the work in MS and COM and improve the cooperation in the area of IPR protection.

9.4.15.2. OPERATIONAL INFORMATION

The COPIS system will be operational on 1/04/2013. Estimated usage figures are as follows:

- Number of AFAs¹⁹ = 10 000 per year;
- Number of INFs²⁰ = 70 000 per year;
- Increase in database size = 1TB per year.

9.4.16. SMS

9.4.16.1. BUSINESS DESCRIPTION

SMS is a system to collect and disseminate the specimens of stamps, seals and certificates used for goods presented at the EU border for importation or transit; the Member States may then perform probes of the shipments and documents.

¹⁹ AFA – Application For Action

²⁰ INF - Infringement

The Commission provides the Member States and other co-operating countries with the specimens of stamps, seals and certificates in the context of several administrative co-operation procedures. With these they can perform probes of shipments and documents.

The issuing bodies of the stamps, seals and certificates in the various countries must provide the Commission with the specimen information. The Commission is responsible for the dissemination of it.

When goods are presented at the EU border, for importation or transit, they are accompanied by documents and/or authentication attributes such as stamps, seals, signatures, etc. These may be subject to forgery, usually with the aim of obtaining a more advantageous tariff regime. In order to fight fraud, the Commission co-operates with the competent government authorities in partner and third countries. Partner countries are those which are closely involved in implementing the co-operation procedure.

9.4.16.2. OPERATIONAL INFORMATION

The database contains more than 2.300 specimen definitions. Every attachment can contain further details in terms of stamps, signatures, etc.

On average, the system registers about 300 data-capture actions per year.

9.4.17. DDS2

The DDS2 system is a collection of various applications composed of one common module and applications disseminating information for a given information domain.

9.4.17.1. DDS2-CM

The DDS2-CM is a restricted domain used for translation and statistics purposes. It permits to:

- Consults/Browses the data imports following transfer for the production applications (TARIC3, CS/MIS, EBTI3, CS/RD, etc.);
- Gets statistics over the number of requests done following several criteria (year, month, week; application; functions, etc.);
- Manages translations in all official languages related to the screens of this domain.

9.4.17.2. DDS2-COL

The DDS2-COL domain covers/disseminates public information coming from the CS/RD application with the following services:

- Queries/displays information concerning the Customs Offices involved in Transit/Export/Import/Excise/EOS/RSS: name, address, phone number, opening hours, holidays, etc.;
- Allows downloading of the XML files;
- Manages the translations in all official languages related to the screens of this domain through a specific restricted access URL.

9.4.17.3. DDS2-EBTI

The DDS2-EBTI domain covers/disseminates public information coming from the EBTI3 application with the following services:

- Queries/displays all non-confidential European Binding Tariff Information (with images)
- Manages the translations in all official languages related to the screens of this domain through a specific restricted access URL.

The operations management of this application falls under the responsibility of the IT Service Management contractor.

9.4.17.4. DDS2-EOS

The DDS2-EOS domain covers/disseminates public information coming from the EOS application with the following services:

- Permits to validate AEO certificates;
- Obtains detailed information about authorised economic operators (when given prior agreement);
- Obtains detailed information about sharing authorities;
- Obtains detailed information about registering authorities (see DDS2-COL);
- Obtains detailed information about competent customs authorities (see DDS2-COL);
- Manages the translations in all official languages related to the screens of this domain through a specific restricted access URL.

9.4.17.5. DDS2-ECICS

The DDS2-ECICS domain covers/disseminates public information coming from the ECICS application with the following services:

- Queries/Displays a repository of 300.000 chemical substances in all EU languages along with their tariff classification in the Combined Nomenclature;
- Manages the translations in all official languages related to the screens of this domain through a specific restricted access URL.

9.4.17.6. DDS2-EXPORT

The DDS2-EXPORT domain covers/disseminates public information coming from the CS/MIS application with the following services:

- Allows retrieval of the status of an Export movement based on its Movement Reference Number (MRN);
- Manages the translations in all official languages related to the screens of this domain through a specific restricted access URL.

9.4.17.7. DDS2-SEED

The DDS2-SEED domain covers/disseminates public information coming from the SEED application with the following services:

- Allows the internet user to verify online the Excise Number and if the response is positive, the system also permits to know which kind of excise product the Economic Operator is permitted to handle;

- Manages the translations in all official languages related to the screens of this domain through a specific restricted access URL.

9.4.17.8. DDS2-SURV

The DDS2-Surveillance domain covers/disseminates information coming from the Surveillance application with the following services:

- Allows to consult the public surveillance information based on the origin and/or surveillance types;
- Manages the translations in all official languages related to the screens of this domain through a specific restricted access URL.

9.4.17.9. DDS2-SUSP

The DDS2-Suspensions domain covers/disseminates public information coming from the Suspensions application with the following services:

- Publishes public information on autonomous tariff suspensions, in preparation or in force;
- Manages the translations in all official languages related to the screens of this domain through a specific restricted access URL.

9.4.17.10. DDS2-TARIC

The DDS2-TARIC domain covers/disseminates public information coming from the TARIC3 application with the following services:

- Allows to browse the nomenclature in all EU languages and all EU measures relating to imports and exports;
- Allows search for geographical areas;
- Allows search for regulations;
- Provides the facility to retrieve/get reports on relevant information such as duty rates and regulations;
- Includes Quota information;
- Manages the translations in all official languages related to the screens of this domain through a specific restricted access URL.

9.4.17.11. DDS2-TRANSIT-MRN

The DDS2-TRANSIT domain covers/disseminates public information coming from the CS/MIS application with the following services:

- Allows retrieval of the status of a Transit movement based on its Movement Reference Number (MRN);
- Provides the EMAP (Transit Movements Electronic Map);
- Manages the translations in all official languages related to the screens of this domain through a specific restricted access URL.

9.4.17.12. DDS2 OPERATIONAL INFORMATION

The following table details the number of hits per DDS2 domain for a period of 12 months between 01/09/2011 and 31/08/2012:

DDS2- Domain	Hits for the period between 01/09/2011 and 31/08/2012
DDS2-COL	2.553.116
DDS2-EBTI	15.259.395
DDS2-ECICS	1.541.229
DDS2-EXPORT	28.895
DDS2-EOS	4.529.469
DDS2-SEED	8.161.804
DDS2-SURV	558.068
DDS2-SUSP	174.983
DDS2-TARIC (incl. DDS2-QUOTA)	18.540.878
DDS2-TRANSIT	26.581

Table 6: DDS2 operational figures for 01/09/2011- 31/08/2012 period

9.4.18. EOS

9.4.18.1. BUSINESS DESCRIPTION

The main business function of the EOS system is to support a safer and more secure end-to-end supply chain while facilitating legitimate trade. The Union Customs Code requires that traders provide the customs authorities with information on goods prior to import and export to/from the European Union.

The EOS IT system is a central repository of all the EORI records and of all the AEO applications and certificates of the EU. Member State can check in real time the EORI and AEO data with the objective to process properly the customs declarations.

EOS stores information on 3.3 million legal entities registered in the 27 EU Member States that come into contact with customs administrations. Sharing this information between MS avoids the need for economic operators to register in each member state to perform customs operations, significantly reducing red tape and the costs for doing business.

9.4.18.2. OPERATIONAL INFORMATION

Active number of registered Economic Operators: **3378419**

Active issued AEO certificates grouped by type:

AEOC (applicable for simplified procedures)	5603
AEOS (applicable to security)	321

9.4.19. EOS-MRA**9.4.19.1. BUSINESS DESCRIPTION**

The Authorised Economic Operator Mutual Recognition project aims to provide a system to exchange AEO data between the EU and its partner countries (i.e. Japan, USA, Norway, Switzerland, China, Russia, Australia, etc.).

AEO MR objectives:

- Customs processes facilitation and harmonisation through computerisation of declarations and data exchanged. Access to the AEO data will be made more widely and easily available;
- Trade facilitation granting benefits to partner country's AEO;
- Recognition of AEO status in a larger number of non-EU partner countries.

AEO MR benefits:

- control and facilitate the movement of goods into and out of the internal market through efficient import and export procedures;
- increase the competitiveness of European trade through a reduction of compliance and administrative costs and an improvement in clearance times;
- facilitate legitimate trade through a coordinated approach relating to the control of goods;
- improve the safety and security of citizens with regard to dangerous and illicit goods.

There are for the moment Mutual Recognition Agreements with Japan, Switzerland, Norway, and with USA. Discussions have started with China and Canada.

AEO Mutual recognition with Japan

On June 24, 2010, EU and Japan signed the Decision establishing mutual recognition of AEO between them. This mutual recognition offers enhanced trade facilitation opportunities to certified AEO traders on both sides who have invested in the security of their supply chains.

This means that certified companies in both the EU and Japan can expect fewer controls on their shipments. This advantage is granted to holders of a European AEO certificate upon the Import procedure which possess the AEO certificate Safety (AEO-S) or the certificate simplified customs procedures/safety (AEO-F) and which gave consent regarding the exchange of AEO-data between the EU and partner countries.

A temporary solution has been found to identify the Japanese certified companies in the customs systems. The Entry Summary Declaration should mention the code Y031 together with the data element 'Transport document' and the unique identifier of the Japanese holder of the AEO-certificate.

The 'temporary solution' with Japan is operational.

AEO Mutual recognition with USA

On 18 December 2010, EU and USA agreed on establishing mutual recognition of AEO between the EU and USA. The related implementation plan foresaw to split the operational IT implementation of the exchanges of information on AEOs from EU to the USA to two phases:
1) phase 1 (transmitting of EU exporter data)- by 01/06/2012;
2) phase 2 –by January 2013.

This has been implemented as scheduled and the exchange of mutual recognized AEO data is occurring automatically from system to system.

AEO Mutual recognition with Switzerland and Norway

Implementation following an agreed solution between the system owner and the Member States. Operational target date by 2013.

Globally Networked Customs (GNC)

The GNC concept is an initiative of several members of the World Customs Organisation (WCO). The objective of the GNC concept and initiative is to standardize the way Customs authorities exchange information. The arrangements will be Customs-to-Customs and stay on a voluntary basis. The GNC approach will consist of providing elements such as protocols, standards and guidelines.

The different GNC initiatives are organised in 'utility blocks'. A utility block is a specific part of the Customs business process, explained in simple yet comprehensive terms that everyone can understand.

One of the utility blocks in which the EU was active was the "AEO mutual recognition" utility block (refer to 'GNC Utility Block – AEO Mutual Recognition Proposed by EU and US') with the following purpose:

- To specify the process that regulates the information interaction between partner countries, and involved traders, that subscribe to an AEO Mutual Recognition Arrangement/Agreement (MRA);
- To enable each of the partner countries to grant benefits to AEO programme members of all other partner countries;
- To provide future partner countries negotiating a Bilateral AEO MRA with a template (this UB) for completing the technical annex of the Bilateral AEO MRA.

The Mutual Recognition Agreement implementation that was developed by the EU and USA was the basis of this utility block and consequently can be taken as a reference implementation.

9.4.19.2. OPERATIONAL INFORMATION

The number of EU Economic Operators with an AEO certificate that have given their consent to provide the relevant information to third countries: **5103**

The exchange with Japan is currently performed on a monthly basis.

The exchange with USA is performed on a daily basis.

9.4.20. RSS

9.4.20.1. BUSINESS DESCRIPTION

Goods carried on a ship sailing from an EU port for another EU port in the Customs territory of the Union normally leave the Customs territory to enter it again when the ship arrives at the

other port. This means in general terms that the Customs status of all goods has to be proven to the Customs (as if the ship entered the EU from a third country). This includes those goods that were in free circulation until they left the port of departure since union goods lose their status when they are removed from the Customs territory of the EU.

For this reason, all goods that are carried by sea are deemed to have non-union status at the time of introduction into the Customs territory of the Union.

However, shipping services that operate exclusively between two or more EU ports can apply for the status of an authorised 'Regular Shipping Service' (RSS). Once this status is granted, the Customs authorities consider that the goods carried on those services do not leave the Union Customs territory and the status of union goods does not need to be proven. Such services can operate as bridges between two or more points in the Customs territory of the Union where there are no Customs checks on either end of the bridge. However, non-union goods carried by these services must be placed under the Customs transit procedure⁵.

RSS is, thus, a simplification offered for vessels that ply only between ports situated in the customs territory of the Union and may not come from, go to or call at any points outside that territory or in a free zone of control type I within the meaning of Article 799 IP of a port in that territory (Article 313a IP). The goods that are carried by these vessels are presumed to be union goods and are not subject to customs formalities.

It is subject to prior authorisation by the customs authorities (Article 313b IP). The application must be submitted to the customs authorities of the Member State in whose territory that company is established or, failing this, in whose territory it has a regional office. The authorising customs authority seeks the agreement of the customs authorities of the other MS concerned.

Such companies must, inter alia:

- determine the vessel(s) to be used for the RSS and specify the ports of call once the authorisation is issued;
- undertake that on the routes of RSS, no calls will be made at any port in a territory outside the customs territory of the Union or at any free zone of control type I in a port in the customs territory of the Union, and that no transshipments of goods will be made at sea;
- undertake to register the names of the vessels assigned to regular shipping services and the ports of call with the authorising customs authority.

In 2010, the authorisations for Regular Shipping Services (RSS) were updated, as established by Commission Regulation (EC) No 177/2010 of 2 March 2010 (OJ L 52, 3.3.2010, p. 28), which stated that RSS authorisations must be stored and processed in the 'electronic information and communication system referred to in Article 14x of Regulation (EEC) No 2454/93'. The RSS application is a centrally developed centrally operated IT system (light client) which consolidates all RSS applications and authorisations in a single repository accessible by all MS in order to satisfy this legislation. The RSS light client allows customs officers to retrieve all information pertaining to RSS applications and RSS authorisations. It also provides a facility for the consultations between the National Administrations, ensuring that the same procedure is universally and correctly applied for all.

9.4.20.2. OPERATIONAL INFORMATION

RSS is still in its uptake phase with Member States still in the process of entering their authorisations. Most Member States have very few authorisations (less than 20), with even the

more frequent users having less than 100 authorisations. The system is not heavily used on a daily basis as new applications are not submitted frequently and changes are of a light nature, e.g. vessel names and ports. Most Member States have one or two users accessing the system.

An estimation of the system usage can be found below. Actual figures can only be provided once the Member States have completed their initial data entry which is planned for the end of 2012.

Activity	Count per day
New RSS applications	100
New consultations	100
New RSS authorisations	100
New re-assessment activities	100
Search activities	1000
View activities	500
PDF files produced	500

Table 7: RSS count

9.4.21. EBTI3

9.4.21.1. BUSINESS DESCRIPTION

EBTI is a system for exchanging and consulting Member States' goods classification decisions and, therefore, their tariff treatment and application of trade policy measures.

The Commission has a procedure in place for information on the tariff classification of goods, provided by the European customs authorities, in order to achieve the following objectives:

- to ensure the uniform application of the tariff classification rules within the European Union;
- to eliminate the differences in the application of tariff classification rules amongst different traders within the EU;
- to ensure the equality and the legal protection of the operator in terms of decisions taken by the different customs authorities.

In order to assure effective management of the procedure, a computerised system has been created to hold all BTI-related information. This system, named EBTI (European Binding Tariff Information), has the following business requirements:

- to ensure the transparency of customs information and to provide a guarantee of equality of treatment for the operators of the Union;
- to allow customs authorities to verify, when they have to classify specific goods, whether a classification decision has already been taken for similar goods by another European customs authority;
- to facilitate the classification of goods by allowing investigation of whether there are any classifications for goods with a similar designation;

- to allow the services of the Commission to ensure coherence of classification by the different national authorities, by searching for divergent or incorrect classifications;
- to look for attempted fraudulent practice and misuse of the procedure by operators (e.g. multiple requests by the same operator);
- to follow the effective application of the invalidation of BTIs.

9.4.21.2. OPERATIONAL INFORMATION

Total number of BTIs in database	712,901
Total number of active BTIs in database	459,859
Number of BTIs created in 2011	51,496
Number of BTIs created in 2012 (status of 10/12/2012)	50,201

9.4.22. ECICS2

9.4.22.1. BUSINESS DESCRIPTION

The ECICS2 system is a tool for all parties concerned with chemicals in international trade (legislators, economic operators, customs, tax or statistical authorities), as well as specialists (chemists, translators and scientific editors) and the general public all over the world (via the DDS-2 on the Europa Web portal).

It makes it possible to identify internationally marketed chemicals in an unambiguous manner for customs, legal and statistical purposes. It contains about 35 400 names for approximately 28 600 chemicals in the European Union (EU) official languages, with their Combined Nomenclature (CN) customs classification, the industry-standard CAS Registry Number (CAS RN) and the Customs Union and Statistics Number (CUS) assigned by DG TAXUD.

The chemical names are internationally recognized names and they are the simplest and the most systematic ones such as the ISO, INN (International Non-proprietary Names for Pharmaceutical Substances), and IUPAC nomenclature names.

Moreover, ECICS2 has an IUPAC name translation module in 9 languages of the EU-27 which is unique in the world. The ECICS2 system helps to avoid divergences and fraud, and consequently assists in the smooth operation of the internal market. For example, some information is available but classified as confidential, such as synonyms of chemical names commonly used by smugglers or other dishonest operators to avoid detection by the customs authorities.

In the near future, ECICS2 will include the ILIADe application which is a shared directory of the analytical methods developed by the Italian Customs Agency. The Italian administration is not able to continue to maintain and support the ILIADe application. Therefore the Customs Laboratories Steering Group requested DG TAXUD to take over this application in order to secure its maintenance and operational continuity. The integration of ILIADe in the ECICS2 application is scheduled to be available by February 2013.

9.4.22.2. OPERATIONAL INFORMATION

The database contains information for 119.388 chemical substances. It is planned to extend this database up to 300.000 chemical substances.

At the moment the database is quite small but it is expected that the size of the database will grow rapidly because of the large amount of attachments which will be included in the database.

ECICS2 has currently 193 users which is close to the estimated growth reported previous years (about 200).

9.4.23. ISPP

9.4.23.1. BUSINESS DESCRIPTION

ISPP (IPR) is a system currently used to manage information on inward processing authorisations.

The inward processing arrangements allow EU operators to be relieved from import duties for components imported from third countries with a view to being processed in the EU and subsequently re-exported. Inward processing is categorised as a customs procedure with economic impact. Therefore the use of this regime is conditional upon granting an authorisation by the customs authorities. This authorisation contains all particulars and conditions in relation to the use of the procedure.

The main objective of the application is to manage information concerning the IPR (Inward Processing Relief) authorisations. The system facilities allow registering applications for import with a view to being processed and re-exported (inward processing) and decisions regarding granting, rejection, annulment, revocation.

9.4.23.2. OPERATIONAL INFORMATION

In 2012, the database increased by 883 cases to reach a total of 13.898 cases with information about inward processing.

9.4.24. QUOTA2

9.4.24.1. BUSINESS DESCRIPTION

Quota-2 is a system allowing the direct communication between Member States concerning tariff quotas.

The Quota-2 system is an evolution of the TQS for the management of tariff quotas.

For a number of products, a reduction of the customs duty payable is allowed for limited quantities of imports. This limitation takes the form of tariff quotas. Tariff quotas may apply to imports of a specified origin, normally within the framework of preferential tariff arrangements, or to imports of all origins.

As the EU is a customs union, tariff quotas are managed centrally by the Commission. The Taxation and Customs Union DG performs this management in the name of the Commission via the Quota-2 database (except in the case of tariff quotas managed by import licence, where the management is normally the responsibility of the Agriculture DG).

9.4.24.2. OPERATIONAL INFORMATION

quotas active in 2011	1,915
quotas active in 2012	1,260
drawing requests in 2011	196,860
drawing requests in 2012	183,937
returns received in 2011	1,526
returns received in 2012	1,968
number of allocations in 2011	238
number of allocations in 2012 (taken on 10/12/2012)	223

9.4.25. SURV2

9.4.25.1. BUSINESS DESCRIPTION

Surveillance of both imported and exported quantities for economic or anti-fraud reasons.

This application satisfies the requirement for the surveillance of the movement of goods inside and outside the EU. These requirements are motivated by the fight against fraud or the need for urgent data in connection with the possible application of tariff safeguard clauses. Free-trade arrangements concluded since 2000 between the EC and certain third countries (e.g. Mexico) include a requirement for the EU to monitor the quantities of EU goods for which proof of origin is issued with a view to obtaining the benefit of a tariff quota in that third country.

9.4.25.2. OPERATIONAL INFORMATION

The database contains about 676,655,455 surveillance data records and approximately 1,992 different report-definitions have been established.

Number of surveillances in 2011	113
Number of surveillances in 2012	357
Number of surveillance numbers	2235
SDRs received in 2011	175,852,835
SDRs received in 2012	667,006,759

9.4.26. TARIC3

9.4.26.1. BUSINESS DESCRIPTION

On the basis of the Combined Nomenclature, TARIC sets the relevant rates of duty, other EU levies and other specific EU measures for each type of goods.

The aim of the TARIC is to be a compilation of the EU tariff, commercial and agricultural legislation, codified in a unique and consistent way. It is implemented by a central database managed by DG Taxation and Customs Union.

By integrating and coding these measures, the TARIC secures their uniform application and gives all economic operators a clear view of all measures to be undertaken when importing or exporting goods. It also makes it possible to collect EU-wide statistics for the measures concerned.

It should be noted that the TARIC contains tariff measures (third country duty, suspension of duties, tariff quotas and tariff preferences), agricultural measures (agricultural components, additional duties on sugar and flour contents, countervailing charges and refunds for export of basic agricultural goods), commercial measures (antidumping measures, countervailing duties, safeguard measures, retaliation measures), measures relating to restriction of movements (import and export prohibitions, import and export restrictions and quantitative limits) and measures for gathering of statistical data (import and export surveillances).

All **tariff rates and associated trade policy measures** and information (quotas, anti-dumping duties, etc.) are controlled via a central database managed by the Commission. Some **500 000** changes annually have to be made to this database. Member States replicate this database via daily updates into their national systems so that customs officers can use this information for customs treatment of goods entering and leaving the union, which is much more efficient than every Member State building their own database. The central database prevents delays in applying tariff measures and potential discrepancies between different countries related to encoding errors and interpretation of the legislation. Equal treatment of traders and trade facilitation is also reinforced. Since 2007 the Customs Programme has spent 3.7 million euro on the tariff database, avoiding the need for every Member State duplicate this effort.

9.4.26.2. OPERATIONAL INFORMATION

Statistics concerning the TARIC database are as follows:

- 25,821 active regulations;
- 23,074 active nomenclature codes;
- 85,150 active measures. More than 71,000 data-capture actions for measures were registered in 2008.

All changes are extracted from the system every day and transmitted to the Member States in order to update the tariff systems at national level.

It should be noted that the TARIC system has been operational since September 1994, implying several millions of historical rows contained in the database.

9.4.27. TATAF

9.4.27.1. CSI BRIDGE

CCN\CSI plays a main role in the DG TAXUD technical architecture, as it provides secure message exchange among Taxud Domain applications and National Domain applications of different national administrations.

For example between the Directorate General and the Member State administrations, the CCN/CSI Bridge is the link between CCN network queues and the BEA Weblogic application servers, where different applications used by DG TAXUD or MSA are deployed. CCN/CSI Bridge is a J2EE application, which contains two Message Driven EJB (Enterprise Java Bean). Each of them is triggered when one of the incoming queues contains new messages. When this happens a simple mapping is made, and the messages are forwarded to the outgoing queue.

9.4.27.2. HTTP BRIDGE

The HTTP CCN Proxy Bridge ensures the integration between the CCN network and the web-logic environment with respect to HTTP communication. It provides a seamless integration between both environments without the introduction of any constraint on the applications deployed in the web-logic environment.

An important concept implemented by the CCN network is the concept of delegated authentication and authorisation. A user proves his identity versus the local CCN gateway. All other gateways have a “trust relationship” with the local CCN gateway and therefore trust the identity embedded in each request originating from the local gateway.

9.4.27.3. UM

The User Management Module (UM) provides management services on the WebLogic security infrastructure and enables an administrator to manage the security policies of an application and its users. The User Management Module operates at the functional level. This means it encapsulates the Weblogic security infrastructure with its groups and group memberships. The User Management Module also enforces a password policy to the individual users.

9.4.28. SPEED2

9.4.28.1. BUSINESS DESCRIPTION

SPEED2 is designed to be an Enterprise Service Bus for data exchange within DG TAXUD and it provides the following features:

- Message transformation, filtering, routing and validation;
- Multiple transport channels: JMS, MQ, AS2 (HTTP), AS3 (FTP), Web Services, Oracle direct database access;
- CSI-based interoperability through CCN/CSI;
- Other services: XML/EDIFACT conversion, monitoring, logging, and statistics.



Figure 7: SPEED2

SPEED2 is based on the combined usage of the following main products:

- Vivansa lxr.CCN – CCN/CSI connector;
- Oracle BPEL – BPM engine;
- Oracle Business Rules – Business Rules engine;
- Oracle B2B - Exchange of business documents between trading partners;
- Oracle Service Bus – Enterprise Service Bus;
- Oracle Enterprise Gateway - First line of defence in the DMZ designed to secure, accelerate, and integrate all types of traffic;
- Oracle Enterprise Manager Grid Control - centralised monitoring, administration and lifecycle management for the entire platform.

The main benefits brought by the SPEED2 platform are:

- One single platform performing the message transformation as well the communication towards the external (non-CCN) world;
- Support for multiple business processes;
- Increased scalability, to cope with a forecasted growth in number of users and volumes of data;
- Reduced cost, due to usage of standard products (no specific developments) and rationalisation of the maintenance process;
- Enhanced monitoring and error detection facilities;
- Enhanced configurability, flexibility and maintainability;
- Enhanced reliability, in particular through active clustering and fail-over mechanism;
- Enhanced security through the Oracle Enterprise Gateway and secure protocols.

9.4.28.2. OPERATIONAL INFORMATION

SPEED2 is currently in testing phase and will become operational in 2013.

9.5.FUTURE PERSPECTIVES

9.5.1. PERSPECTIVE 2020

The IT master Plan study realised in 2011-12 analysed the necessary IT Strategy and Plan together with the required resources in view of the 2020 perspectives.

The report of this study was the main IT input for the realisation of the Multi Annual Strategic Plan (MASP). This document updated annually serves the purpose of consolidating the planning and projects for the implementation of the UCC and eCustoms legislations, extended with the Safety and Security policy in the perspective of 2020.

The MASP document consists of a main body providing the vision and objectives of electronic Customs plus covering the aspects of Governance and management and six annexes of which annex 1 provides the overall implementation timeline in the form of a Gantt chart and annex 2 provides the scope and overall description and scheduling of each of the projects to be realised.

The MASP document is reviewed annually and as it contains a long term and high level view the projects and plans contained on it may suffer variations on this annual review.

The projects planned for the next 10 years in the area of EU Customs as described in the current version of the MASP are grouped in the following manner:

- A first group '**Customs European information Systems**' lists the project fiches procedures and projects on which common agreement exists on the scope and time plan and progress can be made.

- A second group '**Customs European initiatives needing further study and agreement**' contains projects, as, the title indicates, where further discussion will be required before it can find its final concrete place in the IT plan.

- A third group '**Customs International Information Systems**' concerns the projects managed by international organisations, where the EU and its Member States play an active role, but are not the project organisers or owners.

- A fourth group '**Customs Cooperation initiatives and technological developments**' concerns efforts to strengthen cooperation between Member States and to make progress in the field of technology in order to create new functions in the planned EIS.

9.5.2. SOA IMPLEMENTATION

One of the principles of the IT Strategy for EU Customs is:

The future IT systems shall be designed and implemented using service oriented architecture to favour the emergence of flexible, modular, easy to change, IT systems that benefit from the reuse of existing functionality in another MS or in the Commission.

The impact of SOA implementation is hard to assess, however it is easy to identify that this impact strongly relates to almost all areas of IT activity as for example: architecture viewpoints and methods; system design and patterns; development methods; technical platforms and services; operations; organisational aspects; business process modelling; etc..

Therefore in the context of DG TAXUD and EU Customs systems and in relation to this contract the impact of an eventual SOA implementation would affect almost all work packages.

While SOA implementation is a strategic objective for DG TAXUD, it will in all cases stay secondary to other objectives as operations and IT delivery. Therefore the SOA implementation requires a calculated and measured implementation taking into account its numerous aspects, so that the organisation can still assume its obligations with no negative impact on operational or delivery processes.

While the implementation of SOA is understood to imply a learning process and an extra effort, the impact on resources needs to be limited and has to relate proportionality to the realistically expected benefits of SOA.

The strategic principle above proposes a gradual implementation by applying SOA only to future new systems which will coexist with legacy systems; furthermore the implementation of the SOA methods and technologies also implies a coexistence of traditional methods with the newly introduced SOA and a gradual evolution.

The gradual implementation and the priority on operations and delivery imply that the implementation of the SOA must guarantee a continuous state of operational stability whenever an organisational, methodological, architectural or technical evolution takes place.

For DG TAXUD SOA implementation is not black and white, the implementation should also be accompanied by a proper set of indicators that measure not only the degree of implementation but also the benefits reported by that implementation. DG TAXUD shall require at all times to be aware of the level of SOA implementation and its benefits, so as to determine the best balance between effort and benefits of SOA principles application to our systems.

9.5.3. CUSTOMS DECISIONS

This project is one of the new systems to implement in the context of the UCC. So far the project is still in its inception phase. A pilot has been conducted by the development contractor during 2012.

9.6. CUSTOMS CENTRAL APPLICATIONS – ARCHITECTURAL ASPECTS

Most of the customs central applications are developed based on a DG TAXUD home-made framework called TATAF. This is not to be considered as a standard off-the-shelf framework but a combination of code which is available to be integrated in the application to be developed, autonomous components such as the CsiBridge and HTTPBridge and a set of principles to be followed.

The following applications have not been developed according this framework as they were developed in their initial version before the development of TATAF: CS/RD, CS/MIS, STTA, SSTA, TTA. These applications are subject to be re-developed in the future.

Furthermore, DDS2 can be considered as a specific implementation although several TATAF elements have been used.

9.6.1. OVERVIEW OF THE TARIFF APPLICATION TECHNICAL ARCHITECTURE FRAMEWORK (TATAF)

In 2001, DG TAXUD started to develop most of its applications following a new technical framework based on the J2EE standards.

The following figure gives an overview of the various components of the architecture:

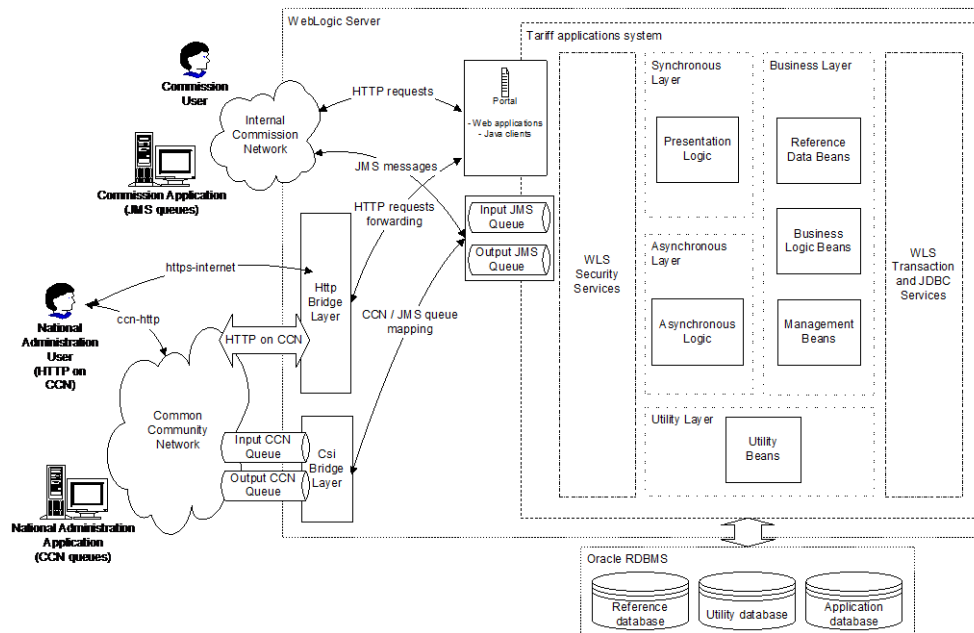

Figure 8: Overview of the TARIFF Application Technical Architecture

The BEA WebLogic Server (WLS) application server supports the whole system. WLS is an implementation of Java 2 Enterprise Edition (J2EE). Notably, the system relies on WLS for deployment, security, and transaction management.

The applications have as a common requirement to keep information in a persistent storage. All persistent data is stored in the Oracle RDBMS. Note that the different databases depicted in the figure only represent logical data separation. It does not suppose physical separation of data in different database instances.

Whenever messages have to be exchanged asynchronously, the Java Messaging Service (JMS) queuing mechanism provided by WLS is used. Two important properties of those queues are the following:

- They can participate in transactions. This means messages can be put into or removed from such queues within a transaction and the operation will be committed or rolled back according to the results of other operations in the same transaction.
- A message can be automatically removed from such a queue if it cannot be read or processed for any reason. This message is then put into an exception queue that can be managed by an administrator.

There are two types of usage of the systems by the national administrations. The national administration can access the Commission systems from system-to-system, meaning direct communication between server applications without the direct intervention of an end user. System-to-system usage communicates through CCN queues. The CsiBridge layer maps CCN concepts on WLS concepts. As a result, the other layers do not depend on CCN.

The second type of usage uses the HTTP protocol to connect interactive end users to the Commission systems. In this type of usage, the interactive user has to connect to the CCN network in order to authenticate himself. Once the user is authenticated, he has the option to continue using the CCN network or to redirect to a HTTPS connection over the public Internet (please note that this last option is not operational anymore but is still part of the framework) . The HttpBridge layer handles all HTTP communication originating from national administrations.

The 'tariff applications system' is subdivided into several logical layers that interact with each other.

The business layer hosts all the application logic. This includes the implementation of the business logic specific to each tariff application, and the implementation of some management services (e.g. statistical inquiries, etc). This layer also provides services to manage the reference data.

The tariff applications system provides two different access paths. The first is a portal, which is actually the entry point for each tariff application. This portal provides links to the different interactive applications. The second access path is a JMS queue, which is actually the entry point for system-to-system asynchronous applications.

The synchronous layer supports the interactive applications. It is mainly composed of presentation logic. The asynchronous layer supports the system-to-system interface. Both layers interact with the business layer to process the messages coming from the users.

The utility layer provides a set of common services shared by the applications and by the different layers (e.g. document storage).

Finally, as explained above, the CsIBridge and HttpBridge layer is responsible for the mapping between the CCN system and the WLS system.

9.6.2. DDS2 FRAMEWORK

The DDS2 system is a collection of different applications and only used for dissemination purposes. The architecture of the DDS2 system can be depicted as follows:

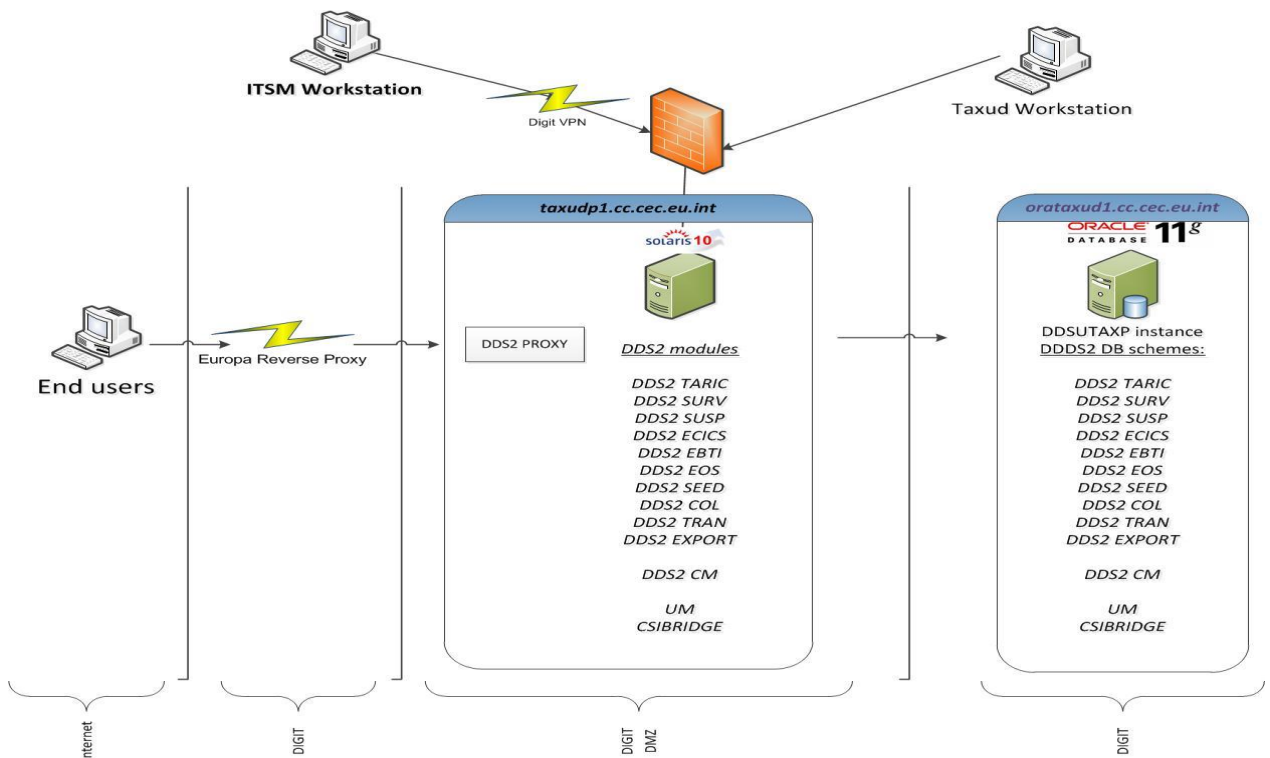

Figure 9: Overview of the DDS2 Architecture Framework

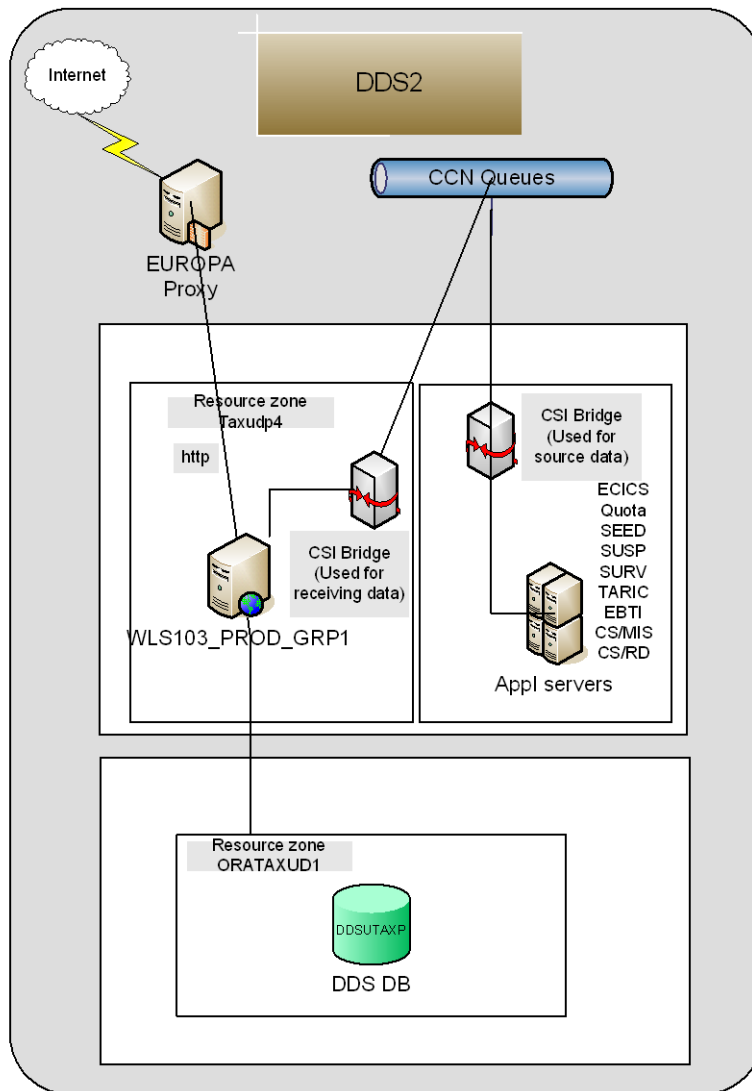

Figure 10: DDS2 Network Diagram

The Oracle component contains the data to be disseminated and is updated via import modules processing data coming from various production systems (TARIC3, EBTI3, CS/RD, etc.). The data is stored following the UTF-8 character set encoding scheme (an implementation of the UNICODE character set).

The production systems send the update files via the CCN network. The CCN interface module manages the CCN queues and activates the various import modules.

The DDS modules are implemented based on the standard J2EE platform (Weblogic Server). Those are built and deployed following the classic three-tier architecture (JSP, Java Beans, Oracle RDBMS) by re-using some TATAF architecture principles (such as xml exchange between client and server).

9.7.IT STATISTICS – BUSINESS OPERATIONS SUPPORT

The statistics are provided for a reference period of 1 year (01/09/2011-31/08/2012).

9.7.1. INCIDENT MANAGEMENT

9.7.1.1. SPECIFICATION AND SOFTWARE INCIDENTS

A total of **258** production/conformance incidents were **opened**.

By priority and application:

Application	Critical	High	Medium	Low	Total
ART2		1	2	3	6
CN		2	4		6
CRMS	1	2	14	4	21
CSIBRIDGE			1		1
CS-MIS		1	5	4	10
CS-RD				1	1
DDS2-CM			1		1
DDS2-COL			4	2	6
DDS2-EBTI			8	3	11
DDS2-ECICS			7	2	9
DDS2-EOS			4		4
DDS2-EXPORT			1		1
DDS2-SEED			2		2
DDS2-SURV			1	4	5
DDS2-SUSP		1	3	1	5
DDS2-TARIC			8	2	10
DDS2-TRANSIT			4		4
EBTI3		1	8	2	11
ECICS2				1	1
EOS(AEO/EORI)		14	19	7	40
ISPP	1				1
NCTS		1			1
QUOTA2		3	6	7	16
RSS		3	1	1	5
STTA			1		1
SURVEILLANCE2		1	5	2	8
SUSP			2	1	3
TARIC3		3	52	9	64
TTA		2	1	1	4
Total	2	35	164	57	258

Table 8: Specification and software incidents opened

A total of **242** production/conformance incidents were **closed**.

By priority and application:

Application	Critical	High	Medium	Low	Total
ART2			2	1	3
CN		2	3		5
CRMS	1		16	9	26
CSIBRIDGE			1		1
CS-MIS		2	6	3	11
CS-RD			3		3
DDS2-COL			3		3
DDS2-EBTI			1		1
DDS2-EOS			2		2
DDS2-SEED			2		2
DDS2-SURV				3	3
DDS2-SUSP			2		2
EBTI3		1	9	2	12
EOS(AEO/EORI)		13	9	8	30
ISPP	1				1
NCTS		1	1		2
QUOTA2		3	13	2	18
RSS		3			3
SMS			2	2	4
STTA			1		1
SURVEILLANCE2		1	7	2	10
SUSP			6	4	10
TARIC3		3	80	2	85
TTA		2	1	1	4
Total	2	31	170	39	242

Table 9: Production/conformance incidents closed

9.7.1.2. REQUEST FOR INFORMATION

A total of **1845 RfIs** (Request for Information) related to production/conformance were opened.

By priority and application:

Application	Critical	High	Medium	Low	Total
ART2		1	2	3	6
ART2		1	32	4	37
CN		10	22	1	33
COPIS			1	1	2
CRMS		3	28	5	36
CSIBRIDGE			6	2	8
CS-MIS		23	71	29	123
CS-RD		22	61	90	173
DDS2-CM		2	4	9	15
DDS2-COL		1	13	8	22
DDS2-EBTI		3	14	11	28
DDS2-ECICS			10	3	13
DDS2-EOS		2	15	2	19
DDS2-EXPORT			1	2	3
DDS2-SEED			3	2	5
DDS2-SURV			2	2	4
DDS2-SUSP		2	7	2	11
DDS2-TARIC		13	30	11	54
DDS2-TRANSIT			2	3	5
EBTI3		2	22	7	31
ECICS2			3	1	4
ECS		44	77	34	155
EOS(AEO/EORI)		2	71	20	93
HTTP Bridge			1		1
ICS		8	66	55	129
ISPP			4	1	5
NCTS	4	281	181	86	552
QUOTA2		3	19	2	24
RSS		2	6	5	13
SMS		2	1	3	6
SPEED/ECN			3	2	5
SPEED2			1	1	2
STTA		1	2	2	5
SURVEILLANCE2		3	22	7	32
SUSP		8	16	3	27
TARIC3		30	106	21	157
TTA		1	3	3	7
Total	4	470	928	443	1845

Table 10: RfIs opened

A total of **1858 RfIs** related to production/conformance were **closed**.

By priority and application:

Application	Critical	High	Medium	Low	Total
ART2		1	34	4	39
CN		10	23	1	34
COPIS			1	1	2
CRMS		4	28	6	38
CSIBRIDGE			6	2	8
CS-MIS		24	73	28	125
CS-RD		21	62	90	173
DDS2-CM		2	4	8	14
DDS2-COL		1	14	7	22
DDS2-EBTI		3	14	11	28
DDS2-ECICS			10	3	13
DDS2-EOS		2	15	2	19
DDS2-EXPORT			1	2	3
DDS2-SEED			3	1	4
DDS2-SURV			2	2	4
DDS2-SUSP		2	6	1	9
DDS2-TARIC		12	28	11	51
DDS2-TRANSIT			2	3	5
EBTI3		2	22	7	31
ECICS2			3	1	4
ECS		44	78	36	158
EOS(AEO/EORI)		2	74	21	97
HTTP Bridge			1		1
ICS		8	68	58	134
ISPP			4	1	5
NCTS	4	281	181	91	557
QUOTA2		3	19	2	24
RSS		2	6	4	12
SMS		2	1	3	6
SPEED/ECN			3	2	5
SPEED2			1	1	2
STTA		1	3	3	7
SURVEILLANCE2		3	22	7	32
SUSP		8	16	3	27
TARIC3		30	106	22	158
TTA		1	3	3	7
Total	4	469	937	448	1858

Table 11: RfIs closed

9.7.2. CHANGE MANAGEMENT

A total of **483 change requests** were **opened**.

By priority and application:

Application	High	Medium	Low	Total
ART2	1	61		62
CN		7	2	9
CRMS		42		42
CS-MIS		35		35
CS-RD		1		1
CS-RD2		18		18
DDS2-CM		1		1
DDS2-COL		4	1	5
DDS2-EBTI		8		8
DDS2-ECICS		2		2
DDS2-EOS		6		6
DDS2-EXPORT		1		1
DDS2-SEED		1		1
DDS2-SURV		2		2
DDS2-SUSP	1	11		12
DDS2-TARIC		5		5
DDS2-TRANSIT		3		3
EBTI3	1	22		23
ECICS2		19		19
ECS		9		9
EOS(AEO/EORI)	6	40	23	69
HTTP Bridge		1		1
ICS		11		11
ISPP		1		1
NCTS		5		5
QUOTA2		5	1	6
RSS	1	29	12	42
RSS Phase2		3		3
SMS		5		5
SPEED/ECN		2		2
SSTA		1		1
STTA		3		3
SURVEILLANCE2		3		3
SUSP		24		24
TARIC3		33	4	37
TTA		6		6
Total	10	430	43	483

Table 12: Change requests opened

A total of **152 change requests** were closed.

By priority and application:

Application	High	Medium	Low	Total
ART2	1	5		6
CN		2		2
CRMS		28		28
DDS2-SUSP	1	6		7
EBTI3	1	3		4
ECS		6		6
EOS(AEO/EORI)		12	1	13
ICS		8		8
ISPP		1		1
NCTS		3		3
SMS		7	1	8
SPEED/ECN		2		2
SSTA		1		1
STTA		4		4
SURVEILLANCE2		13		13
SUSP		10		10
TARIC3	5	26		31
TTA		5		5
Total	8	142	2	152

Table 13: Change requests closed

9.7.3. RELEASE MANAGEMENT

In total **49 full releases** (implementing change requests) and **80 patches and hotfixes** (corrective and/or evolutive maintenance) have been delivered.

By application:

Application	Number of full releases	Number of patches/hotfixes
ART2	1	2
CN	2	7
COPI5	1	0
CRMS	1	4
CS/MIS	1	6
CS/RD	1	4
CSI-BRIDGE	1	0
DDS2-CM	1	1
DDS2-COL	1	1
DDS2-EBTI	1	1
DDS2-ECICS	1	0
DDS2-EOS	1	1
DDS2-EXPORT	1	1
DDS2-SEED	1	2
DDS2-SURV	1	1
DDS2-SUSP	1	0
DDS2-TARIC	1	0
DDS2-TRANSIT	1	0
DDSPPEED	1	0
EBTI3	4	5
ECICS2	3	0
EOS	3	6
ISPP	1	0
QUOTA2	2	6
RSS	1	4
SMS	1	0
SPEED2	2	0
SPEED-ECN	1	0
STTA	1	2
SURV2	1	5
SUSP	1	4
TARIC3	3	12
TTA	4	5
UM	1	0
Total	49	80

Table 14: Number of full releases and patches/hotfixes delivered

10. PORTFOLIO OF SYSTEMS, APPLICATIONS, AND IT SERVICES FOR TAXATION AND EXCISE (UPDATED 10/2012)

Important note: the information provided below is an extract from the FITSDEV3 call for tender terms of reference.²¹ It aims at giving the tenderers a full, clear and precise description of the Taxation and Excise environment.

This section provides information on:

- DG TAXUD business environment;
- The portfolio of DG TAXUD TES and applications;
- The foreseen evolution of the portfolio in the coming years, including future developments;
- TES operations.

10.1. DG TAXUD BUSINESS ENVIRONMENT²²

10.1.1. IT IN SUPPORT TO EU TAX POLICY

Taxation and Excise TES contribute to the achievement of DG TAXUD's mission. They support the real-life implementation of tax and excise policy across the EU for the benefit of its citizens, businesses and Member States.

The competence to implement taxation and excise TES is shared between the Commission and the Member States, each with specific tasks and responsibilities. The resulting technical environment is very heterogeneous, with the exchange of information between taxation administrations of the 27 Member States as an essential and recurrent element.

Heterogeneity also characterises the users of those systems. In fact, these systems must address the business requirement of different and independent user communities in charge of specific "branches" of taxation policy such as VAT, excise, direct taxation and recovery of claims.

The scope of the various systems varies: from systems for exchanges between administrations to those impacting citizens and businesses. Also the volumes and frequency of exchanges involved vary greatly.

The main business objectives of TES and applications for **taxation** and **excise** can be summarised as follows:

- To assist Member States in **fighting against fraud and tax evasion**:
 - TES allow for the rapid exchange of secure information and thus support the fight against different types of tax fraud and evasion.

This is the case in the areas of:

- VAT, through the VAT Information Exchange System (VIES);
- savings income, through the Taxation on Savings system (ToS);

²¹ See http://ec.europa.eu/taxation_customs/common/tenders_grants/tenders/index_en.htm.

²² This section describes the business or policy context of Taxation and Excise TES. "Business" and "policy" are used as synonyms here.

- excise duties, through the Excise Movement and Control System (EMCS);
- To **reduce compliance costs** for citizens and economic operators by enabling, for instance, the refund of VAT from a Member State in which an economic operator is not established, through the publication of the most relevant information (including VAT number identification) on the Europa web site, the official website of the EU or to allow economic operators to fulfil the VAT obligations they have in Member States in which they are not established, via their own tax administrations, under certain conditions,
- To **provide information** to citizens and economic operators online via the Europa website, the official website of the EU. For instance, DG TAXUD manages the "Taxes in Europe" database (TEDB), the European Commission's on-line information tool covering the main taxes in force in the Member States. The system contains information on around 600 taxes, as provided to the European Commission by the Member States.

The Fiscalis 2013 EU cooperation programme supports Taxation and Excise TES and applications²³. In November 2011, the Commission adopted a proposal for a new EU cooperation programme replacing the current Fiscalis 2013 programme.

10.1.2. RECENT ACHIEVEMENTS AND FUTURE DEVELOPMENTS²⁴

In recent years, new Taxation and Excise TES and applications became operational: as an example of Taxation TES, the VAT Refund system entered in operation in 2009; the exchange of forms for Recovery and Direct Taxation in 2010.

In the medium term (2015), the Mini One Stop Shop will simplify VAT compliance for EU and non-EU economic operators supplying electronic services, telecommunications and broadcasting activities to EU customers.

Regarding Excise TES, EMCS has been used across the whole EU since January 2011. Since January 2012, EMCS is also used for administrative cooperation purposes.

DG TAXUD anticipates a **significant increase of the volume of IT activities and IT operations for the years to come**. This is due to the expected growing operational volume of VAT-related systems, of EMCS, and possible new systems for exchange of data between the EU and third countries.

The developments described below are only a projection of potential IT systems development in the coming years. Projections are based on the current EU policy and legislative framework. It must be underlined that this list does not reflect current formal requirements or priorities of the Commission or Member States in the field of taxation and excise. The list is not exhaustive. It remains to be established if Member States would be favourable to some of these initiatives. It is merely indicative of the type of future evolutions possible. Uncertainty remains considerable, given the fact that for initiating a TES the adoption of a legal basis is generally required.

²³ http://ec.europa.eu/taxation_customs/taxation/tax_cooperation/fiscalis_programme/index_en.htm

²⁴ Within this section, reference is made to several Taxation and Excise TES and applications.

Regarding the **taxation** business thread, several activities are envisaged in the foreseeable future:

- In the field of VAT, the implementation of Council Regulation (EC) 904/2010²⁵ on administrative cooperation and combating fraud in the field of VAT will represent the main evolution. The follow up to the Commission Communication on the Future of VAT of 6 December 2011 may result in significant change to VIES. DG TAXUD however does not expect that changes, if any, will become operational before 2015²⁶;
- The entry in operation of the VAT Mini One Stop Shop (MOSS), on the basis of Directive 2008/8/EC²⁷. MOSS will integrate the current VAT on e-Services system (VoeS). The start of operations is due on 1 January 2015;
- In the field of direct taxation a Feasibility Study has been launched on the implementation of the FISCO Recommendation²⁸. This could lead to the launch of a new trans-European system i.e. FISCO, with possible interactions with OECD member countries. DG TAXUD expects such system will not become operational before 2015;
- The implementation of Council Directive 2011/16/EU²⁹ on administrative cooperation in taxation might lead to an increase of information exchange between Member States tax administrations;
- Regarding administrative cooperation among the Member States, new IT systems may be requested to support EUROFISC information exchanges³⁰.
- Recent developments at international level as regards the US Foreign Account Tax Compliance Act (FATCA) open new perspectives for strengthening automatic information exchange between Member States and third countries thus improving transparency at a global level;
- Frequent requests are received to extend administrative cooperation with members of the OECD as well as to extend the above mentioned possible, future FISCO system. At the moment international agreements are not in place to enable such an extension;
- Possible new systems in the 2015-2020 timeframe could include an IT system to support taxation on road transport means, or on financial transactions.

Regarding **excise**, the following activities are envisaged in the foreseeable future:

²⁵ OJ L 268, 12.10.2010, p. 1

²⁶ The main changes might involve:

- Defining alternative ways to implement the destination principle, specifically ensuring payment to the tax authority of the customer (1) by involved banks or (2) by the supplier, through a "one stop shop" mechanism;
- A common EU approach to the Standard Audit File for Tax (SAFT).data warehouse model, whereby the taxable person uploads predefined transaction data structured in an agreed format into a secured VAT data warehouse that is maintained by the taxable person and accessible to all Member States' tax authorities.

²⁷ OJ L 44, 20.2.2008, p. 11

²⁸ [http://ec.europa.eu/taxation_customs/resources/documents/common/whats_new/c\(2009\)7924_en.pdf](http://ec.europa.eu/taxation_customs/resources/documents/common/whats_new/c(2009)7924_en.pdf)

²⁹ OJ L 64, 11.3.2011, p. 1

³⁰ For additional background information on EUROFISC please consult:

http://ec.europa.eu/taxation_customs/resources/documents/2011-02-07_eurofisc_pressrelease_en.pdf

- The extension of EMCS to duty paid and distance selling, and to follow up movements under simplified procedures;
- The potential merge of the System for Exchange of Excise Data (SEED) into AEO/EORI³¹ with a view of consolidating economic operators' registers; the harmonisation of guarantee management across other domains;
- The development of new functionalities, such as common risk assessment;
- Further possible developments of EMCS: the creation of a single window, allowing economic operators to enter declarations from any Member State for all their movements; the set-up of a one stop shop system for excise;
- The enhancement of the Test Application (TA) for EMCS to support automated testing by National Administrations.
- The definition of an EU wide common IT architecture for Taxation and Excise TES and applications.

10.1.3. OTHER ACTORS IN TAXATION AND EXCISE

10.1.3.1. POLICY UNITS³²

Unit R4 has frequent contacts with the following policy units of DG TAXUD:

- Unit C1 "VAT and other turnover taxes". The mission of unit C1 is, through analysis and design work, to adapt the VAT legislation to the requirements of the single market. For the short and medium-term, the work primarily concerns the modernisation and the simplification of the current regime. The management of the existing legislation, in particular the questions of interpretation and application, represents an important factor for the operation of the current regime.
- Unit C2 "Environment and other indirect taxes". The mission of unit C2 is, within the framework of the Internal Market to ensure that the Union excise system permits the maximum collection of revenue with the minimum of disruption to trade. It provides an Internal Market framework for the use of fiscal tools in environment, transport and energy policy.
- Unit C4 "Tax administration and fight against tax fraud ". The mission of unit C4 is to provide the necessary legislative framework and environment at EU level to foster administrative cooperation and mutual assistance between Member States in the interest of the smooth functioning of the internal market and the fight against fiscal fraud in particular.
- Unit D2 "Direct Tax Policy and Cooperation". The mission of unit D2 is to contribute to EU tax policy development and co-ordination of direct tax matters by developing and following up Union legislation and other appropriate initiatives in the field of direct tax in line with the Treaty objectives and in particular the needs of the Internal Market, as well as monitoring existing legislation in the Member States and in relevant third countries.
- Unit D4 "Economic analysis, evaluation and impact assessment support". The mission of Unit D4 is to provide evidence base and in-depth economic analysis on all aspects of customs and taxation relevant to the EU.

³¹ http://ec.europa.eu/taxation_customs/common/databases/index_en.htm

³² "Policy units" and "business units" are used as synonyms in this document.

- Unit R3 "Information, management of programmes" will also be a stakeholder. The unit is responsible among others for the management and implementation of the co-operation programmes Customs 2013 and Fiscalis 2013, and their successors.

The organisation chart of DG TAXUD can be found on the Europa website. This organisation chart is subject to change:

http://ec.europa.eu/taxation_customs/common/about/structure/index_en.htm

10.1.3.2. MANAGEMENT AND REGULATORY COMMITTEES

The Commission is assisted by Management and Regulatory Committees which are composed of delegates from the Member States and representative of the Commission. These Committees have been set up via appropriate legal provisions.

The Management and Regulatory Committees in the excise and taxation areas are:

Committee related to both the excise and taxation areas

The Fiscalis Committee: a management committee composed of representatives of the Member States and chaired by the Commission. If the Committee approves the measure, the Commission is authorised to implement it. The Fiscalis Committee handles questions in relation with the Fiscalis Programme which finances activities in the field of taxation (notably seminars, multilateral controls, training and IT systems).

Committees related to the excise area only

According to Council Directive 2008/118/EC, the Commission must be assisted by the Committee on Excise Duty.³³ This Committee is composed of representatives from the Member States and chaired by the Commission. It assists the Commission with the planning, management and coordination of the setting up of the system, ensuring that EMCS meets the needs of business.

The Committee on Excise Duty is responsible for:

- approving the project's overall terms of reference and master and management plans;
- coordinating the organisational and procedural changes in the user environment required by the new system;
- setting business objectives, priorities and milestones;
- taking strategic decisions, inter alia on the basis of Excise Computerisation Working Party (see below) recommendations, on matters relating to the legal, procedural, organisational, financial and technical aspects of EMCS;
- approving milestone executive documents;
- controlling the project at a strategic level.

Note that the Committee on Excise Duty is the only entity empowered to take decisions on the basis, in particular, of proposals made by the ECWP;

The Committee on Excise Duty also plays the role of EMCS Steering Committee.

Committees related to the Taxation area only

³³ Previously called Excise Committee.

- SCAC (Standing Committee on administrative co-operation): a regulatory committee composed of representatives of the Member States and chaired by an official of the Commission. If the Committee approves a proposal, the Commission is authorised to implement it. SCAC handles questions related to the application of Council Regulation (EU) No 904/2010. SCAC is assisted by its sub-Committee, the SCIT;
- SCIT: the Technical sub-Committee of the SCAC handling matters related to information technology. It is composed of representatives of the Member States and chaired by an official of the Commission. The SCIT assists the SCAC in its work examining and reporting on all technical aspects related to VAT. Final decisions in the field of information technology are taken by SCAC;
- Recovery Committee: a regulatory committee composed of the representatives of the Member States and chaired by an official of the Commission. It takes decisions by qualified majority foreseen under Article 205 (2) of the Treaty. If the Committee approves the measure, the Commission is authorised to implement it. It is competent in the field of recovery of claims relating to refunds, levies and duties in the field of the sugar sector, import duties, export duties, value added tax, excise duties, taxes on income and capital, taxes on income and insurance premiums, interest, administrative penalties and fines and costs incidental to the claims. The Recovery Committee handles questions in relation with Council Directive 2010/24/EU;
- CACT (Committee for Administrative Cooperation in Taxation): a committee composed of representatives of the Member States and chaired by an official of the Commission. CACT handles questions related to the application of Council Directive 2011/16/EU. It gives an opinion by qualified majority on proposals of implementing acts presented by the Commission: when the Committee gives a positive opinion, the Commission is authorised to endorse the implementing act. Beyond the question of implementing acts, the CACT is also a forum for discussion of any other subject or action aimed at improving administrative cooperation in (direct) taxation: it shares experience, draws up rules in the fields concerned, produces guidelines on any aspect deemed necessary. The CACT is assisted by an eFDT (Electronic Forms for Direct Taxation) Steering Group as well as various working groups when appropriate. The practical implementation may also be discussed or coordinated with the OECD Secretariat and Member Countries when appropriate.

10.1.3.3. WORKING GROUPS AND WORKING PARTIES

The Commission can set up working groups to assist it on business or technical subjects. The working groups or working parties which are important in the context of this call for tenders are:

Working Groups related to the Excise area

To carry out its duties in relation to EMCS, the Committee on Excise Duty has set up the EMCS Computerisation Working Party (ECWP). The ECWP is a forum for discussing IT and functional aspects of EMCS.

The ECWP has the following responsibilities:

- contribute to and follow up the production of the system specification;
- ensure the Commission and Member States' terms of reference, project plans and quality plans are submitted in time for inclusion;
- discuss the implementation of legal, procedural, organisational and computer aspects and adopt any recommendation to be submitted for adoption by the Committee on Excise Duty;

- identify any common areas of development which could allow economies of scale;
- receive reports on results, progress, delays and any problems or issues that may arise;
- detect problems and assign responsibilities for corrective action;
- deliver an opinion on functional and technical documents, and project deliverables;
- submit its recommendations and reports to the Committee on Excise Duty.

Working Groups related to the taxation area

The working groups with which DG TAXUD Unit R4 has direct contact in the taxation area are:

- Working Party IV on Direct Tax is a working group composed of the Member States and chaired by an official of the Commission. This working group is competent should questions arise about the interpretation of Directive 2003/48/EC;
- Working Group on Administrative Cooperation in the field of direct tax (WG ACDT): composed of representatives of the Member States and chaired by an official of the Commission. WG ACDT deals with activities relating to administrative cooperation not covered by Directive 2011/16/EU. In particular, it constitutes a forum where strategies are developed and discussion takes place on all questions associated with taxation of savings and it assumes the tasks relating to practical implementation at IT level of Directive 2003/48/EC on mutual assistance in the field of direct tax. The practical implementation of taxation on savings may also be discussed with the OECD Secretariat or Member Countries when appropriate;
- Working Group "Structures of the Taxation Systems": working group composed of representatives of the Member States and chaired by the Commission. In this working group, exchange of views takes place between the Commission and the Member States on the content and technical specifications of the Taxes in Europe Database.

10.2. THE PORTFOLIO OF TAXATION AND EXCISE IT SYSTEMS AND APPLICATIONS

The following sections describe the main business, functional, application and technical aspects of key Taxation and Excise TES and applications.

10.2.1. OVERVIEW

The presentation of the portfolio is structured along two business threads:

- Taxation TES and applications, divided into:
 - VAT related systems, dedicated to the exchange of VAT related information;
 - Recovery. This area focuses on exchanging structured information to support the recovery of taxation due;
 - Direct Tax. It consists of several projects aiming at exchanging information related to direct tax payments between the Member States;
 - Other tax-related systems;
 - Applications common to VAT, Recovery and Direct tax.
- Excise TES and applications:

This thread includes EMCS and smaller and medium-size systems and applications (SEED, TA, CS/MISE, and MVS).

It is important to understand upfront that all Taxation and Excise TES and applications are underpinned by the Common Communication Network (CCN) operated by DG TAXUD. Please refer to Section 11 for more detailed information on CCN/CSI. The administrations of the Member States are linked with each other through an electronic network that is private and highly secured called the Common Communication Network (CCN). The European Commission ensures that this network is operational on a 24 hours basis with a permanent availability rate. Due to the critical nature of most tax-related IT systems, business continuity and availability are essential.

Taxation and Excise TES have been by far the main consumer of the CCN services in recent years, both in term of number of transactions end in terms of volume. Forecasts suggest that this will remain for the future: it is estimated that the tax-related volume of operations will double in the next four years.

10.2.1.1. TAXATION TES AND APPLICATIONS

VAT related systems	
<p>VAT Information Exchange System (VIES) – system to enable information to be exchanged on intra-EU supplies between the competent authorities of the Member States for the purpose of VAT control.</p> <p><i>Including the VIES initial application, the VIES monitoring tool, VIES test tools, VAT number algorithms.</i></p>	Operational since 1992
<p>VIES on the Web –an extension of VIES allowing obtaining limited registration information over the Internet.</p> <p><i>Including VIES-on-the-web configuration tool.</i></p>	Operational since 2001
<p>VAT exchange of forms</p> <p><i>Including VAT eForms test tool</i></p>	Operational since 2008
<p>VAT on eServices (VoeS) – system for charging, declaring, collecting and allocating VAT revenues in connection with e-Services supplies provided to a consumer established in a Member State by e-services traders who have neither established their business nor have a fixed establishment within the territory of the Union.</p> <p><i>Including test tool</i></p>	Operational since 2003 (Will be phased out and integrated in the Mini One Stop Shop in 2015).
<p>Mini One Stop Shop – system (electronic procedure) allowing taxable persons trading in more than one Member State to fulfil their VAT obligations in a single place of compliance, which would be the Member State where they are established (or in the Member State of identification in case of third country businesses).</p>	Operational by January-2015
<p>VAT Refund – system (electronic procedure) allowing traders to obtain the refund of VAT from a member State in which they are not established.</p> <p><i>Including test tools.</i></p>	Operational since 2010

Recovery	
<p>Recovery – Exchange of forms</p> <p>Exchange of electronic forms for Uniform Instrument Permitting Enforcement (UIPE) and for Uniform Notification form (UNF).</p>	<p>Operational (recovery of claims)</p> <p>Operational since January-2012</p>
Direct Tax	
<p>Taxation on Savings - a system to exchange information on interest payments by paying agents established in their territories to individuals resident in other Member States.</p> <p><i>Including test tool.</i></p>	<p>Operational since 2006</p>
<p>Tax Identification Number on the web (ToW) – a system to provide a web-enabled interface allowing end-users to verify Taxes Identification Number (TIN) via the Internet for any Member States.</p>	<p>Operational since 2012.</p>
<p>Direct Taxation - exchange of forms.</p>	<p>Operational since 2012</p> <p>Reviews of the forms foreseen January 2013.</p>
<p>Direct Taxation - Automatic Exchange of Information (AEOI) – system for the exchanges related to the Article 8 of Directive 2011/16/EU, and associated test tools.</p>	<p>Operational by 1 January 2015</p>
<p>FISCO (Fiscal Compliance) – system to improve the procedures of the Member States for granting withholding tax relief (pursuant to tax treaties and domestic laws) on cross-border securities income earned by EU investors.</p>	<p>Under Study.</p>
Other tax related systems	
<p>Taxes in Europe Database – system to gather and disseminate information about the main taxes in force throughout the Member States.</p>	<p>Operational since 2007</p> <p>(Possible extension to OECD countries by 2013)</p>
Applications common to VAT, Recovery, Direct Tax	
<p>Generic Test Tool (GTT) – testing application common to VAT, Recovery and Direct Tax</p>	<p>Operational since 2008</p>
<p>Self-Service Testing System (SSTS) – system to increase the ability of Member States to run conformance testing autonomously and to test their own IT development before starting operations within the trans-European network.</p>	<p>Operational since 2012</p>
<p>Taxation related Statistics System (TSS) – common statistics application.</p>	<p>Operational by 2013</p>
<p>eForm editor - application supporting exchange of forms</p>	<p>Operational since 2009</p>

eForm viewer - application supporting exchange of forms	Operational since 2009
Taxation Information and Communication (TIC) , providing the Member States with a Web application through which they will be able to provide the Commission with information (in most part textual) that has to be made available to the other Member States or to the general public via the Internet.	Operational by 2012
eForms Central Application (eFCA) – common application to support the exchange of information between Member States in taxation different domains in the context of the administrative cooperation.	Operational by 2014

Table 15: Taxation systems portfolio overview

Further general information on Taxation TES and applications (e.g. VIES) may be found on the Europa web site³⁴.

10.2.1.2. EXCISE TES AND APPLICATIONS

Excise Movement and Control System	
<p>Excise Movement and Control System (EMCS) – The computerized movement and monitoring system for excisable products under duty suspension.</p> <p><i>Includes SEED, test application (TA), the central services / management information system for Excise (CS/MISE) and MVS e-forms.</i></p>	Operational (phase 3 as from 01 January 2012)
EMCS supporting applications	
<p>System for Exchange of Excise Data (SEED), including SEED on Europa – obligatory electronic database located in each Member State and containing a register of persons who are authorized warehouse keepers or registered traders for excise duty purposes and a register of facilities approved as tax warehouses.</p>	Operational
<p>Test Application (TA) – which supports the Member States in testing their National Excise Applications (NEA) against the Common Domain specifications.</p>	Operational
<p>Central System / Management Information System for Excise (CS/MISE) - provides business statistics on the EMCS system as well as enabling the follow-up of the EMCS movements over the Common Domain.</p>	Operational
<p>Movement Verification System (MVS) – system which allows</p>	Operational

³⁴ http://ec.europa.eu/taxation_customs/taxation/vat/traders/vat_number/index_en.htm

verifying individual movements of goods between two traders.	
--	--

Table 16: Excise systems portfolio overview

Further general information on EMCS may be found on the Europa web site³⁵.

35

http://ec.europa.eu/taxation_customs/taxation/excise_duties/circulation_control/index_en.htm

10.2.2. VAT RELATED SYSTEMS

The VAT system has been implemented as a set of sub-systems following the evolution of EU VAT law.

The EU Internal Market and with it the transitional intra-EU VAT regime came into force on 1 January 1993. This regime abolished controls at fiscal frontiers within the EU and replaced them by an electronic system called the VAT Information Exchange System (VIES). Council Directive 77/388/EEC³⁶ which laid down the fundamental principles of EU VAT law was therefore amended in 1992 to take into account the transitional provisions as well as the introduction of VIES. More recently, the Council adopted a recast of that Directive (Council Directive 2006/112/EC of 28 November 2006)³⁷. Council Directive 2006/112/EC is the current main legal basis of VIES.

On 8 June 2010 Regulation 904/2010/EU (Recast of Regulation 1798/2003) was adopted. This Regulation will have an impact on VIES, although limited. Changes to VIES need to be operational by 1 January 2013.

As regards administrative cooperation in the field of VAT, two provisions are applicable: Council Regulation 904/2010/EC and Commission Regulation 2012/79/EU³⁸. The latter lays down detailed rules for implementing certain provisions of Regulation 904/2010.

10.2.2.1. VAT INFORMATION EXCHANGE SYSTEM (VIES)

10.2.2.1.1. LEGAL BASIS

- Council Directive No 2006/112/EC of 28 November 2006 on the common system of value added tax.
- Council Regulation (EU) No 904/2010 of 7 October 2010 on administrative cooperation and combating fraud in the field of value added tax.

10.2.2.1.2. BUSINESS DESCRIPTION

VIES allows the tax administrations of the Member States to exchange VAT-related data. The establishment of the Internal Market in 1993 simplified business operations across the Member States. However, it also relaxed fiscal controls at the intra-EU borders. To combat the increased risk of fraud, VIES was set up.

Businesses registered for VAT in the Member States which make intra-EU supplies must complete recapitulative statements listing the aggregate value of supplies of goods and services made to VAT registered customer elsewhere in the EU. Economic operators submit this information to their Member States authority competent for VAT control. Member States collect this information and store it on their VIES databases.

Member States tax authorities use and exchange among each other this data to ensure that intra-EU VAT has been correctly accounted for. VIES is also used by economic operators to check the validity of VAT registration numbers of their customers in other Member States. Valid VAT registration numbers are a necessary condition for zero-rating intra-EU supplies.

³⁶ OJ L 145, 13.6.1977, p. 1

³⁷ OJ L 347, 11.12.2006, p.1

³⁸ OJ L 29, 1.2.2012, p. 13

With Regulation 904/2010/EC the Council decided that in the upcoming years VIES will be extended to cover the exchange of additional VAT-related information, such as Trader Activities and Legal form. The same regulation also requires a service level agreement (SLA) that will be agreed between Member States and the Commission, to lay down performance and availability commitments for all national and Commission's VIES components.

10.2.2.1.3. FUNCTIONAL DESCRIPTION

In respect to requirements placed upon Member States, the information exchanged between national VIES applications can be divided into two main categories:

- Identification data enabling a Member State to verify that a particular VAT number from another Member State is valid, or has been valid (VAT and Historical VAT information);
- Turnover data information submitted by traders in every Member State.

VIES implements the following set of processes:

- Request VAT Registration Information;
- Provide VAT Registration Information;
- Request Turnover Information;
- Provide Turnover Information.

10.2.2.1.4. APPLICATION DESCRIPTION

VIES is a distributed TES composed of national VIES applications for exchanges related to registration or turn-over data. VIES uses CCN/CSI.

VIES relies on several supporting applications:

- VMS – VIES Monitoring System allows the IT Service Management (ITSM) contractor of DG TAXUD to monitor the status of the VIES services at each Member States site automatically, in order to detect service failures. VMS is sending on regular basis messages to the Member States and analysing the response to deduce their "live" status;
- VSS – VIES Statistics System provides VIES statistical information concerning the exchange of messages between the Member States through the CCN/CSI network;
- VAT numbers validation routines;
- VTA – VIES Test Application checks the compliance of a VIES server / client and is used for Conformance Testing;
- VIA – VIES Initial Application may be used by Member States as basis of a national application concerning the exchange of messages.

These applications are hosted in the premises of the DG TAXUD contractor in charge of the operations.

10.2.2.1.5. TECHNICAL DESCRIPTION

Each Member State has developed a national VAT database and local applications of VIES. The VIES system provides access from one national database to another. There is no central database. National gateways are connected with each other through CCN/CSI. Member States' environments are very diverse and include IBM Mainframes, UNIX and Windows platforms, Oracle, DB2 and Ingres databases. Among the programming languages COBOL, C, Java, PL/SQL is used.

Below, additional technical information is provided on the VIES supporting applications:

VIES Monitoring System (VMS)

The Monitoring Engine is a Java module running at the IT Service Management Contractor who is responsible for monitoring the compliance of Member State VIES applications with the Service Level Agreement.

VIES Statistics System (VSS)

VIES Statistics system is composed by two applications, the Importing Tool and the Reporting Tool.

VAT numbers validation routines

These routines allow validating the syntax of the VAT numbers as regards the National Construction rules. The Commission maintains ANSI C and Java versions that are distributed to Member States for integration into their own environment, if need be.

VIES Test application (VTA)

This application checks the compliance of a VIES server / client against the VIES functional specification. It is built around the Initial Application. Besides being used as a tool to perform RCT (Remote Conformance Testing), it can also be distributed to Member States to perform LCT (Local Conformance Testing).

The test application is made of a Test Server and a Test Client. Both are used to test the counter part of the VIES system and can be installed separately or together on one machine.

The test client plays a set of tests defined in a scenario. Upon reception of an answer from the national server application under test, it is compared to the expected answer. If both are equal, the test is considered as passed. If discrepancies are found, the tests will be considered as failed.

Upon requests from a national client application under test, the test server checks in its scenario file which answer must be sent back to the client. If no appropriate answer is found in the scenario file, the request is forwarded to the initial application for normal processing.

VIES Initial application (VIA)

The Initial Application is a fully functional VIES application that could be used by the Member States as a fall back solution or by acceding countries³⁹ as a basis for their own developments.

It is composed of:

- A client (1) and a server (2) which are running in the J2EE web container (3). These two components are provided as unpacked files within a normal directory or in a web archive (WAR). These applications use the VIES protocol over HTTP;

³⁹ Acceding country is a term used within the context of EU enlargement. At the time of writing the call for tenders, Croatia is the only acceding country. For more information, please consult:

http://ec.europa.eu/enlargement/countries/check-current-status/index_en.htm

- An HTTP2CSIAdapter (4) which is a proxy application that converts in both directions VIES over HTTP messages into VIES over CSI messages. VIES over HTTP is the protocol used by the client (1) and the server (2) while VIES over CSI is the protocol agreed at trans-European Level. This adapter is written in ANSI C and has been tested over SunOS, Linux RedHat and Linux Suse OS.

The client and server applications connect through JDBC to the database with the VAT information. The database (6) can be any for which a JDBC driver is available.

The different components of the application are running in different containers. Some additional third party software is needed to provide these containers.

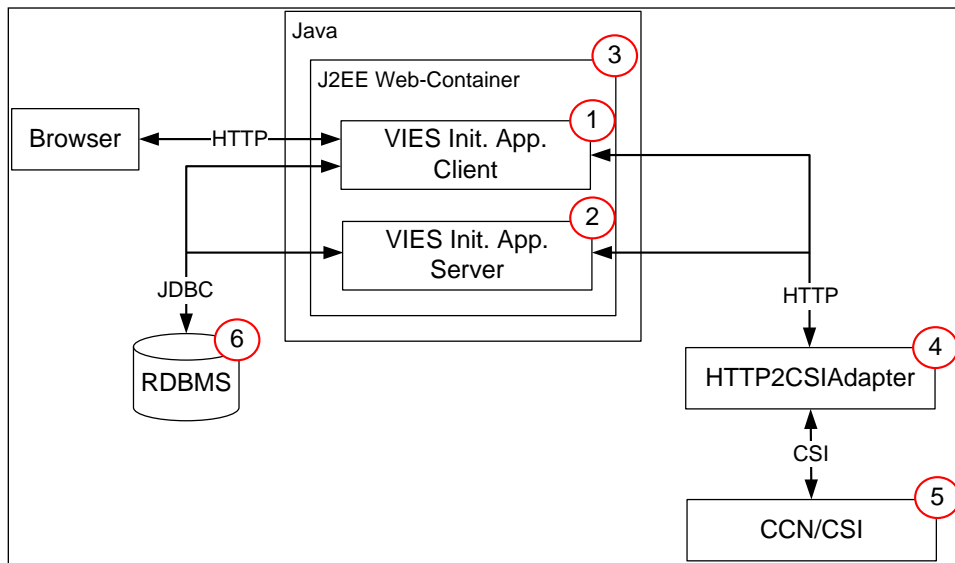

Figure 11: Overview Initial VIES Phase V/Unicode Application

VIES communication modes & types of exchanges

VIES applications support two communication modes:

- A synchronous mode which is used for interactions requiring fast response time and a small amount of data exchanged;
- An asynchronous mode used for interactions with longer response time or with a large amount of data exchanged.

The exchanges consist in either spontaneous or request/responses interactions for the following kind of data:

- VAT and Historical VAT Registration Data. It consists in request/response interactions. A request related to VAT registration data is sent via a R_VATR message and the response conveyed in a D_VATR message. Similarly, Historical VAT Registration Data is exchanged via a pair (request message: R_HVATR / response message: D_HVATR). For use with VIES-on-the-Web an additional message is defined that allows users to provide trader name and address information for validation through Fuzzy Matching;
- Turnover Data. It consists of both spontaneous and request/response interactions.

Once the collection of the recapitulative statements has been completed and the data processed, each tax administration generates and sends spontaneously to all the other tax administrations a so-called F_L1QD quarterly data file. Tax administrations can also request these files for any past quarters, by submitting R_L1F1 requests. In that case, they receive a F_L1F1 file, which can be processed as an F_L1QD.

After the reception of the spontaneous F_L1QD, the recipient tax administration is obliged within 2 working days to report, by means of an O_MCTL message, to the counterpart tax administration any wrong/suspicious VAT identification number provided.

The global value of intra-EU acquisitions of a given trader is requested through a R_L1F2 message while the answer is a D_L1F2 message.

The value broken down of intra-EU supplies to a trader is requested through a R_L2F1 message while the answer is a D_L2F1 message. This information can also be requested, but instead with details of trading partners in a 3rd Member State, through the R_L2F1_3MS message

The value broken down of intra-EU acquisitions of a trader is requested through a R_L2F2 message while the answers are D_L2F2 answer messages.

Request messages (R_L1F1, R_L1C, R_L1CM) are sent by Member States in order to get updated turnover data that was previously exchanged through the L1QD file. A F_L1F1 data file answer must be sent by the requested Member State in answer to the R_L1F1 request.

10.2.2.2. VIES-ON-THE-WEB (VOW)

10.2.2.2.1. BUSINESS DESCRIPTION

VIES-on-the-Web is an extension of VIES which allows traders to access via Internet information on VAT registration numbers issued by the Member States.

When the validation of the VAT identification number is positive, the name and address of the associated economic operator is provided.

Originally only Member States officials were allowed to consult VIES-related information. In October 2001 however the VIES-on-the-web application was put at the disposal of traders, to allow them to verify the validity of VAT numbers of their trading partners.

VIES-on-the-Web can be accessed via the Europa website at: <http://ec.europa.eu/vies>

Some traders have integrated the availability of VIES-on-the-Web information in their daily processes. Therefore, they rely heavily on this service. The success of these services is constantly increasing with the number of queries made by the traders reaching more than 150 million requests in 2011.

10.2.2.2.2. FUNCTIONAL DESCRIPTION

The VIES-on-the-Web service provides a Web-enabled interface for an existing function of the VIES system. The service allows end-users to verify VAT numbers for intra-EU trade via Internet.

It includes the Fuzzy Matching feature that implements the approximate matching of trader name/address. The actual matching process is implemented at Member State level.

When the validation of the VAT identification number is positive, the name and address of the associated economic operator is provided.

10.2.2.2.3. APPLICATION DESCRIPTION

Vies-on-the-Web is an application hosted at the Commission's Data Centre (DIGIT/DC) and interacting with the Member States via the VIES network.

10.2.2.2.4. TECHNICAL DESCRIPTION

VIES-on-the-Web can be viewed as a message broker that dispatches the requests received from the Internet to the relevant Member States via the VIES system.

VIES-on-the-Web offers two interfaces:

- an interactive interface based on HTML pages;
- an applicative interface based on the SOAP protocol.

The application is fully written in Java and hosted in a Weblogic J2EE Application server.

The requests are encapsulated in an XML message within an HTTP request which is transmitted via the CCN Intranet to the appropriate national CCN gateway.

A GAS (Generic Application Server) running on that gateway (maintained by the CCN/TC contractor) converts the HTTP/XML request into a CSI/VIES request that will be processed by the national application.

The response is converted the other way round from CSI/VIES into HTTP/XML. The relevant information is either displayed in an HTML page for the interactive request or encapsulated in a SOAP response for the API service.

10.2.2.3. VAT EXCHANGE OF FORMS⁴⁰

10.2.2.3.1. LEGAL BASIS

- Council Regulation (EU) No 904/2010 of 7 October 2010 on administrative cooperation and combating fraud in the field of value added tax
- Commission Implementation Regulation (EU) No 79/2012 of 31 January 2012 laying down detailed rules for implementing certain provisions of Council Regulation (EU) No 904/2010 concerning administrative cooperation and combating fraud in the field of value added tax

10.2.2.3.2. BUSINESS DESCRIPTION

Electronic forms support the exchange of information in the framework of administrative cooperation⁴¹, either spontaneously or on request via a standardised format.

Forms include requests for information, notifications, recovery measures and precautionary measures, feedback forms, notifications of administrative decisions and information in case of suspected fraudulent operations.

Electronic forms are used to support administrative cooperation in the field of VAT, direct tax or related to the recovery of claims.

10.2.2.3.3. FUNCTIONAL DESCRIPTION

The essential functionalities for the exchange of forms revolve around three major issues:

- information requests, requests for administrative enquiries and exchange of spontaneous data sent by the competent authority of one Member State (the requesting authority) to the competent authority of another Member State (the requested authority);
- notification of an administrative decision to another Member State who communicates it to its taxable person;
- introducing of a simplified form for a fast exchange of information in case of suspected fraudulent operation.

10.2.2.3.4. APPLICATION DESCRIPTION

The exchange of forms is a single standalone application offering the user interface in all EU official languages. This application has to be installed on the end-user workstation.

The Commission has developed a test tool allowing evaluating the compliance of the form implementation to the functional and technical specifications.

The list of forms currently used in the field of VAT and their format is provided in the next table.

Form	Legal base	CCN/Mail2 mailbox	Format
Form "SCAC 2004"	Art. 7 and 15 of Council	VIESCLO	Java

⁴⁰ The terms form, electronic form or eForm / e-form are used as synonyms in this document.

⁴¹ http://ec.europa.eu/taxation_customs/taxation/tax_cooperation/mutual_assistance/index_en.htm

	Regulation (EU) No 904/2010		
Missing Trader Form	Art. 7 and 15 of Council Regulation (EU) No 904/2010	TAXFRAUD	Java
Request for Notification	Art. 25 – 27 of Council Regulation (EU) No 904/2010	VIES CLO	Java
Form on Information on non-established traders	Art. 13 of Council Regulation (EU) No 904/2010	TAXAUTO	MS-Excel
Form on Information on new means of transport	Art. 13 of Council Regulation (EU) No 904/2010	TAXAUTO	MS-Excel
Form on information on VAT refunds to taxable persons not established in the Member State of refund but established in another Member State pursuant to Council Directive 2008/9/EC* ⁴²	Art. 13 of Council Regulation (EU) No 904/2010	N/A	N/A
Form for the communication of statistical information to the Commission	Art. 49(3) of Council Regulation (EU) No 904/2010	TAXUD C4 mailbox	MS-Excel
VAT and / or Excise duty exemption certificate	Directive 2006/112/EC - Article 151 – and Directive 2008/118/EC ⁴³ - Article 13	N/A	

Table 17: VAT exchange of forms

* This information is exchanged between the Member States as part of the VAT refund system, using a XML message sent in a CCN queue.

10.2.2.3.5. TECHNICAL DESCRIPTION

The exchange of forms system consists in a stand-alone Java application generating XML files with the forms content. The XML file only is exchanged between the Member States via the CCN/Mail2 Server. All data is encrypted on the local LAN between the user and the CCN server. All data passing transmitted on the CCN network is encrypted. Secured webmail access to the mailboxes is also possible.

At present, there are 4 CCN mailboxes for the VAT eforms.

Forms are implemented in two phases⁴⁴:

⁴² OJ L 44, 20.2.2008, p. 23

⁴³ OJ L 9, 14.1.2009, p. 12

⁴⁴ This approach is also followed for the forms used in the fields of Recovery and Direct Tax.

- Phase 1 – Specifications. Functional, technical and test specifications are produced. These specifications will be independent of any product that can be used to load/edit/save the form data. A major output of this phase will be an XML schema for each form mentioned before.
- Phase 2 – Implementation. The e-forms are created. Outputs of this phase are revised versions of the functional, technical and test specifications to integrate peculiarities of the DG TAXUD Java implementation. A major output of this phase will be the creation, for each form, of a form implementation directly usable by the Member States.

This approach offers Member States three options to integrate the form solution within their own IT and organisational environments:

1. Use the forms produced during Phase 2.

The forms produced within Phase 2 are used as such by Member States. Member States are only responsible for the translation of the form labels in their national language(s) and organise training sessions for the users of these e-forms.

2. Adapt the forms produced during Phase 2 to best suit the Member State IT and organisational environments.

This solution consists in slightly modifying the forms produced during Phase 2 to best suit the MS environment. Such adaptations can consist in adding some automation functionality, for example to gather some information automatically from a national database.

A selection of the test cases described in the Acceptance Test Specification will have to be run in order to ensure that modified e-forms are compliant with the technical specifications, and more particularly that the XML documents produced are valid as regards the commonly agreed XML schema.

Whenever the genuine form delivered by the Commission needs corrective or evolutive maintenance, Member States having chosen this option will be responsible for integrating the changes in their modified versions of the e-forms and for being ready with the updated release by the agreed deadlines.

3. Build a national solution and do not use the forms produced during Phase 2.

This solution consists in building a full national solution instead of using the forms produced during Phase 2. The XML documents generated by this national form solution must be compliant with the Technical Specification produced during Phase 1. The ITSM2 contractor will assist the Member States in testing this compliance.

All the test cases described in the Acceptance Test Specification have to be run in order to ensure that the national form solution is compliant with the Technical Specifications, and more particularly that the XML documents produced are valid as regards the commonly agreed XML schema.

10.2.2.4. VAT ON E-SERVICES

10.2.2.4.1. LEGAL BASIS

- Council Directive 2006/112/EC of 28 November 2006 on the common system of value added tax;
- Council Directive 2006/138/EC⁴⁵ of 19 December 2006 amending Directive 2006/112/EC on the common system of value added tax as regards the period of application of the value added tax arrangements to radio and television broadcasting services and certain electronically supplied services;
- Council Regulation (EC) No 904/21010 of 7 October 2010 on administrative cooperation in the field of value added tax and repealing Regulation (EC) No 1798/2003⁴⁶;
- Council Implementing Regulation (EU) No 282/2011⁴⁷ of 15 March 2011 laying down implementing measures for Directive 2006/112/EC on the common system of value added tax.

10.2.2.4.2. BUSINESS DESCRIPTION

VAT on e-Services (VoeS) is a special scheme applicable for traders who are not established in the EU but who provide electronically supplied services to non-taxable persons established within the EU.

VoeS is an electronic system for charging, declaring, collecting and allocating VAT revenues in connection with e-Services supplies from e-Services traders who have neither established their business nor have a fixed establishment within the territory of the Union to a consumer established in a Member State.

This simplified system allows the non-established taxable person to use a Member State of identification dedicated web site to access an automated system for registering and declaring VAT on-line. Data is then submitted by electronic means to this Member State of identification by the non-established taxable person. Although the systems are under national responsibility, the Commission has defined quality standards and integrity checking mechanisms, in order to ensure a minimum level of quality throughout the EU.

10.2.2.4.3. FUNCTIONAL DESCRIPTION

This special scheme has led to the implementation of a dedicated system for exchange of information between Member States. The scheme provides for traders not established within the EU, supplying specific e-services, an electronic means of:

- Registration for VAT;
- Submission of VAT return;
- Payment of VAT due.

⁴⁵ OJ L 384, 29.12.2006

⁴⁶ OJ L 264, 15.10.2003, p. 1

⁴⁷ OJ L 77, 23.3.2011, p. 1

Traders can perform these actions in a single Member States of their choice irrespective of the Member State of residence of the non-taxable client.

10.2.2.4.4. APPLICATION DESCRIPTION

The Commission has developed a test application which allows for the verification of compliance of the Member States' applications to the specifications.

10.2.2.4.5. TECHNICAL DESCRIPTION

At national level, Member States collect data via national web sites. The collected data is converted into XML documents that are attached to a CCN/Mail message. Member States are responsible for developing and maintaining their own applications.

As stated above, the Commission has developed and maintains a test application that is used during the conformance tests session to ensure that Member States applications conform to the functional and technical system specifications. This test application is fully developed in Java and uses a MySQL database to store the test data. The following picture depicts the test environment.

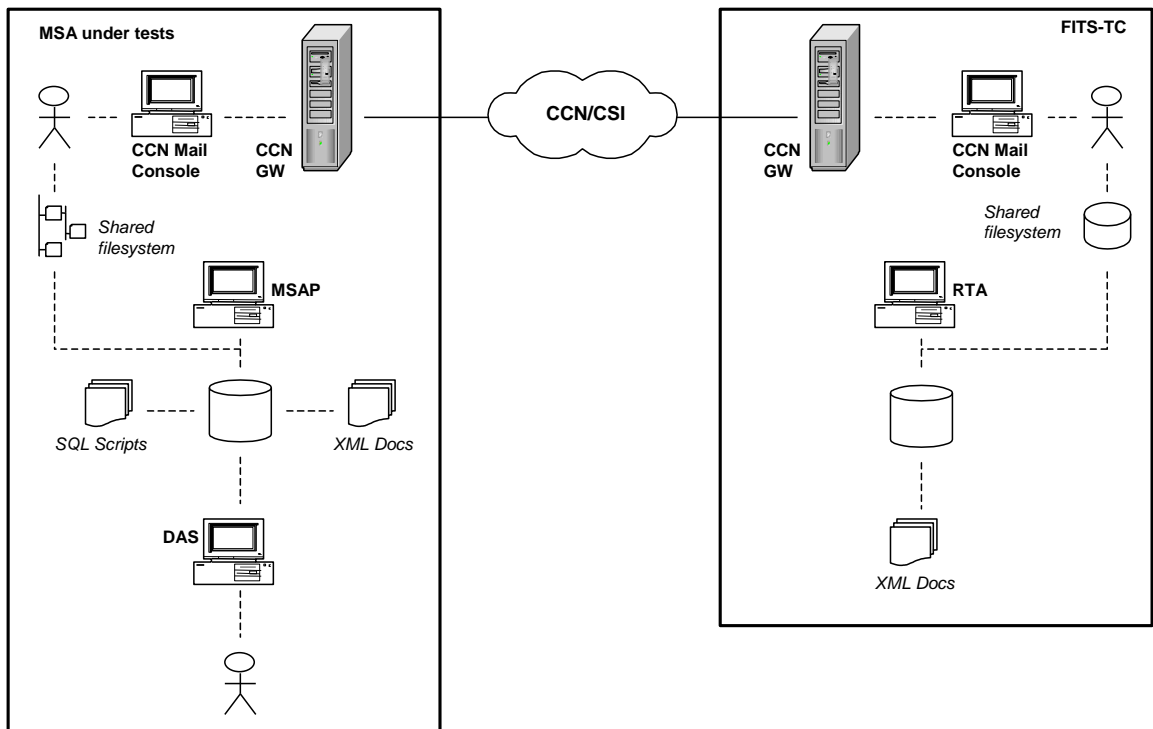

Figure 12: Acceptance testing infrastructure

When playing the role of **Member State of Identification**⁴⁸, the Member State under test fills in its database with the content of the reference test data. This can be done via the so-called Data Acquisition System dedicated to the **Non Established Taxable Persons**⁴⁹, via SQL scripts or via XML documents. The data according to the scenario to be played is extracted from the database and sent to the ITSM2 contractor. The ITSM2 contractor verifies that the

⁴⁸ Member State of Identification (MSID) means the Member State which the non-established taxable person chooses to contact to state when his activity as a taxable person within the territory of the EU commences in accordance with the provisions of legal base.

⁴⁹ NETP – Non Established Taxable Person means a taxable person who has neither established his business nor has a fixed establishment within the territory of the EU and who is not otherwise required to be identified for tax purposes under Article 214 of Council Directive 2006/112/EC;

data received is equivalent to the expected data and inserts it, as would any **Member State of Consumption**⁵⁰, in its database. Any error that occurred during processing will be forwarded to the originating Member State that will take the appropriate actions to solve the problem.

When playing the role of Member State of Consumption, the Member State under test fills in its database with the document received from the ITSM2 contractor and checks if the data has been correctly inserted in the database.

10.2.2.5. VAT MINI ONE STOP SHOP (MOSS)

10.2.2.5.1. LEGAL BASIS

- Council Directive 2006/112/EC of 28 November 2006 on the common system of value added tax;
- Council Directive 2008/8/EC of 12 February 2008 amending Directive 2006/112/EC as regards the place of supply of services;
- Council Regulation (EU) No 904/2010 of 7 October 2010 on administrative cooperation and combating fraud in the field of value added tax.

10.2.2.5.2. BUSINESS DESCRIPTION

The VAT Mini One Stop Shop (MOSS) is a system allowing taxable persons trading in more than one Member State to fulfil their VAT obligations in a single place of compliance, which would be the Member State where they are established (or in the Member State of identification in case of non-EU country businesses).

This special scheme is defined by Council Directive 2008/8/EC, amending the Council Directive 2006/112/EC, for simplifying the obligations of EU trader in the context of distant services provided to EU non-taxable person and more specifically telecommunication services, broadcasting services and electronic services.

This special scheme offers the possibility for EU traders being registered for VAT purposes in one Member State to declare such services provided in the other Member States directly in his Member State of establishment (named Member State of identification) without being obliged to be registered for VAT purposes in other Member States.

The system is expected to become operational by 1 January 2015.

10.2.2.5.3. FUNCTIONAL DESCRIPTION

MOSS implements the following set of processes:

- Non-Established Taxable Person registration;
- Submission of a VAT return;
- Payment of the VAT due.

10.2.2.5.4. APPLICATIVE DESCRIPTION

A test tool will be developed by the Commission to test the compliance of the Member States' applications to the specifications.

⁵⁰ Member State of Consumption (MSCON) means the Member State in which the supply of the electronic services is deemed to take place.

10.2.2.5.5. TECHNICAL DESCRIPTION

MOSS, currently under development, will be supported by an exchange of XML messages through CCN/CSI in asynchronous mode. The chosen paradigm for the exchange of XML messages for MOSS scheme is the datagram paradigm as imposed by the legislation. Request/response messages will only be used for specific enquiries.

10.2.2.6. VAT REFUND

10.2.2.6.1. LEGAL BASIS

- Council Directive 2008/9/EC of 12 February 2008 laying down detailed rules for the refund of value added tax, provided for in Directive 2006/112/EC, to taxable persons not established in the Member State of refund but established in another Member State.

10.2.2.6.2. BUSINESS DESCRIPTION

VAT Refund allows EU traders to electronically submit claims for the refund of VAT paid in Member States where they are not established.

The VAT refund procedure is laid down in Council Directive 2008/9/EC. This Directive simplified the recovery procedure by allowing traders to directly submit an electronic VAT Refund application to their own tax authorities for VAT incurred in another EU Member State.

The VAT Refund system allows:

- a trader registered in a certain Member State to submit an electronic application for a refund of VAT incurred in another EU State. This electronic VAT refund application is made to the tax administration of the Member State where the trader is established (Member State of Establishment) and contains scans of the relevant invoices, where necessary;
- the tax administration of the Member State of Establishment to forward the trader's claim, electronically, to the relevant Member State for processing (Member State of Refund) via CCN.

The Member State of Refund processes the request and notifies the trader directly or via the Member State of Establishment of its decision. The trader will receive the refund of VAT through its Member State of Establishment.

10.2.2.6.3. FUNCTIONAL DESCRIPTION

The VAT Refund system implements the following set of requirements:

- Exchange of messages between Member States of establishment and Member States of refund;
- Relay the receipt notifications and VAT Refund decisions sent from the Member State of refund to non-established taxable person via the Member State of establishment;
- Communicate notification of pro-rata rate adjustment to all the Member States;
- Notify reception of pro-rata rate adjustment by the Member State of refund to non-established taxable person;
- Provide the possibility to make correction on VAT Refund application.

10.2.2.6.4. APPLICATION DESCRIPTION

A test tool has been developed by the Commission to test the compliance of the Member States' applications to the specifications.

A statistical application provides information on the traffic (number of messages and volume), as well as average time to take a decision. The statistic application takes as input the CCN audit files.

10.2.2.6.5. TECHNICAL DESCRIPTION

Each Member State must have an application that communicates with the applications of other Member States using the asynchronous exchange of XML messages through CCN/CSI.

The application communicates via the CCN gateway installed at the Member State site and the CSI stack is used to manage the communication.

10.2.3. RECOVERY

10.2.3.1. EXCHANGE OF FORMS

10.2.3.1.1. LEGAL BASIS

- Council Directive 2010/24/EU⁵¹ of March 16th 2010 concerning mutual assistance for the recovery of claims relating to taxes, duties and other measures
- Commission Implementing Regulation (EU) No 1189/2011⁵² of 18 November 2011 laying down detailed rules in relation to certain provisions of Council Directive 2010/24/EU concerning mutual assistance for the recovery of claims relating to taxes, duties and other measures.

10.2.3.1.2. BUSINESS DESCRIPTION

Exchange of forms supports administrative cooperation for tax recovery⁵³.

10.2.3.1.3. FUNCTIONAL DESCRIPTION

Refer to the function description of VAT exchange of electronic forms.

10.2.3.1.4. APPLICATION DESCRIPTION

The list of forms currently used in the field of Recovery of Claims and their format is provided in the next table:

Form	Legal base	CCN/Mail2 mailbox	Format
Request for Information	Art. 5 of Council Directive 2010/24/EU	See the list below	Java
Request for Notification	Art. 8 of Council Directive	See the list below	Java

⁵¹ OJ L 84, 31.3.2010, p. 1

⁵² OJ L 302, 19.11.2011, p. 16

⁵³ http://ec.europa.eu/taxation_customs/taxation/tax_cooperation/tax_recovery/index_en.htm

	2010/24/EU		
Request for Recovery and/or Precautionary Measures	Art. 10 and 16 of Council Directive 2010/24/EU	See the list below	Java
Uniform Notification Form	Art. 8 of Council Directive 2010/24/EU	See the list below	Java
Uniform Instrument Permitting Enforcement	Art. 12 of Council Directive 2010/24/EU	See the list below	Java

Table 18: Recovery exchange of forms

Depending on the nature of taxes involved, the following mailboxes have been created for exchange of information between Member States in the field of Recovery of Claims:

- a. REC-A-CUST (customs duties);
- b. REC-B-VAT (value added tax);
- c. REC-C-EXCISE (excise duties);
- d. REC-D-INCOME-CAP (tax on income or capital);
- e. REC-E-INSUR (tax on insurance premiums);
- f. REC-F-INHERIT-GIFT (inheritance and gift taxes);
- g. REC-G-NAT-IMMOV (national taxes and duties on immovable property, other than the above-mentioned ones);
- h. REC-H-NAT-TRANSP (national taxes and duties on the use or ownership of means of transport);
- i. REC-I-NAT-OTHER (other taxes and duties levied by or on behalf of the (applicant) State);
- j. REC-J-REGIONAL (taxes and duties levied by or on behalf of territorial or administrative subdivisions of the (applicant) State, excluding taxes and duties levied by local authorities);
- k. REC-K-LOCAL (taxes and duties levied by or on behalf of local authorities);
- l. REC-L-OTHER (other tax-based claim);
- m. REC-M-AGRI (refunds, interventions and other measures forming part of the system of total or partial financing of the European Agricultural Guarantee Fund (EAGF) and the European Agricultural Fund for Rural Development (EAFRD), including sums to be collected in connection with these actions, and levies and other duties provided for under the common organisation of the market for the sugar sector).

10.2.3.1.5. TECHNICAL DESCRIPTION

Refer to the technical description of VAT exchange of electronic forms.

10.2.4. DIRECT TAX RELATED SYSTEMS

10.2.4.1. TAXATION ON SAVINGS

10.2.4.1.1. LEGAL BASIS

- Council Directive 2003/48/EC⁵⁴ of 3 June 2003 on taxation of savings income in the form of interest payments

10.2.4.1.2. BUSINESS DESCRIPTION

The aim of Directive 2003/48/EC is to enable savings income, in the form of interest payments made in one Member State to beneficial owners who are individual residents for tax purposes in another Member State, to be subject to effective taxation in accordance with the laws of the latter. The automatic exchange of information between Member States concerning interest payments is the means chosen to achieve effective taxation of these interest payments in the Member State where the beneficial owner is resident for tax purposes.

10.2.4.1.3. FUNCTIONAL DESCRIPTION

Concerning ToS system, all data collection is performed by the Member States. At EU level, coordination is provided to define the structure of the information to exchange.

10.2.4.1.4. APPLICATION DESCRIPTION

The Commission has developed a test application to verify the compliance of the Member States' applications to the specifications.

10.2.4.1.5. TECHNICAL DESCRIPTION

The system is operational since 2006 and consists in exchanging between the Member States bulk XML data.

Although the Taxation on Savings data to be exchanged according to the Directive cannot be considered as inter-personal messaging, Member States decided to use CCN/Mail2 as infrastructure layer. As a CSI based system would have required additional developments, this has been postponed until business needs justify the investments.

In the beginning of 2006, the SAVINGS-DIR mailbox was created in the CCN/Mail2 messaging facility and the first exchanges took place within the first semester 2006.

Member States collect data and information is structured in a file exchanged between competent authorities.

10.2.4.2. TAX IDENTIFICATION NUMBER (TIN) ON THE WEB (TOW)

10.2.4.2.1. BUSINESS DESCRIPTION

ToW is operational since April 2012. It allows **Paying Agents**⁵⁵ to verify the valid syntax of TIN provided by the **Beneficial Owners**. This tool is limited to checking that the syntax of the

⁵⁴ OJ L 157, 26.6.2003, p. 38

⁵⁵ Council Directive 2003/48/EC defines the concepts of Paying Agent and Beneficial Owner.

TIN is correct according to the construction rules and does not provide any information about the fact that this TIN is assigned to a Beneficial Owner.

10.2.4.2.2. FUNCTIONAL DESCRIPTION

The application allows the users to enter a Tax Identification Number and the issuing country. The application informs the user if the syntax of the number is valid or not.

10.2.4.2.3. APPLICATIVE DESCRIPTION

The application is hosted at the Commission's Data Centre (DIGIT/DC) as a single stand-alone application.

10.2.4.2.4. TECHNICAL DESCRIPTION

ToW is a web-based application written in Java and running on a Weblogic server. It offers a graphical interface with HTML pages for human interactions, as well as a SOAP interface for application interactions.

10.2.4.3. ADMINISTRATIVE COOPERATION -- EXCHANGE OF FORMS

10.2.4.3.1. LEGAL BASIS

- Council Directive 2011/16/EU⁵⁶ of 15 February 2011 on administrative cooperation in the field of taxation and repealing Directive 77/799/EEC

10.2.4.3.2. BUSINESS DESCRIPTION

In parallel with the work being done for the Taxation on Savings, to cater for the provisions of the directive concerning mutual assistance in the field of direct taxation, the Working Group on Administrative Cooperation in the field of Direct Tax has designed electronic forms that are similar to those used in the field of VAT and Recovery.

The forms currently in use are provided in section "Application description" below.

10.2.4.3.3. FUNCTIONAL DESCRIPTION

Refer to the function description of VAT exchange of electronic forms.

10.2.4.3.4. APPLICATION DESCRIPTION

The list of forms currently used in the field of Direct Tax and their format is provided in the next table:

Form	Legal base	CCN/Mail2 mailbox	Format
Request for Exchange of Information	Council Directive 2011/16/EU	MUTASSIST-DIR	Java
Spontaneous Exchange of Information	Council Directive 2011/16/EU	MUTASSIST-DIR	Java
Feedback on the Exchange	Council Directive 2011/16/EU	MUTASSIST-DIR	Java

⁵⁶ OJ L 64, 11.3.2011, p. 1

of Information			
Acknowledgment	Council Directive 2011/16/EU	MUTASSIST-DIR	Java

Table 19: Direct Tax exchange of forms

There is currently 1 CCN mailbox used for the Direct Taxation eforms.

10.2.4.3.5. TECHNICAL DESCRIPTION

Refer to the technical description of VAT exchange of electronic forms.

10.2.4.4. AUTOMATIC EXCHANGE OF INFORMATION (AEOI)

10.2.4.4.1. LEGAL BASIS

- Council Directive 2011/16/EU of 15 February 2011 on administrative cooperation in the field of taxation and repealing Directive 77/799/EEC

10.2.4.4.2. BUSINESS DESCRIPTION

Work has started on the specification of the automatic exchange of information in the field of taxation. The system that will result from this activity is expected to become operational by January 1st 2015.

10.2.4.4.3. FUNCTIONAL DESCRIPTION

N/A.

10.2.4.4.4. APPLICATION DESCRIPTION

N/A.

10.2.4.4.5. TECHNICAL DESCRIPTION

N/A.

10.2.5. OTHER TAX RELATED SYSTEMS AND APPLICATIONS

10.2.5.1. TAXES IN EUROPE DATABASE (TEDBV2)

10.2.5.1.1. LEGAL BASIS

- Decision of the Permanent Committee of Heads of the National fiscal administrations of 16 July 1963

10.2.5.1.2. BUSINESS DESCRIPTION

In collaboration with the Member States, the European Commission publishes a survey of the taxes in force in the EU. It aims at providing all those interested in tax law - university researchers, students, businesses, tax advisers, civil servants, etc. - with a generic yet comprehensive view of the tax systems of the Member States.

The Taxes in Europe Database System is a collection of forms describing the taxes in the Member States. Forms are filled in by the Member States and sent to DG TAXUD for verification and publication on the Europa website. The update can be triggered either by the

Commission or by the Member States themselves. The application also offers a tax reforms tracking functionality and the system has no interactions with others.

10.2.5.1.3. FUNCTIONAL DESCRIPTION

TEDB automates the following processes:

Collection, Storage and Validation of data

1. Collection of data: each Member State is responsible for encoding the information about its taxes in the TEDBv2 system through the Production interface. Member States can create or update taxes, measures and reforms.
2. Storage of data: data encoded by the Member States are stored in a central database.
3. Pre-validation of data: pre-validation of the created or updated tax data by particular Member States users before submission to DG TAXUD through the Validation interface.

Publication of data

1. Validation of data: DG TAXUD checks and validates the modifications before publication, through the Publication Interface.
2. Publication of data: after validation, tax information is made available on the public web site.

Dissemination of data

1. Research of data: Internet users can search and display taxes, reforms and measures data on the public web site.
2. Export of data: Internet users can export a list of taxes or of reforms in a CSV file.

10.2.5.1.4. APPLICATION DESCRIPTION

TEDBv2 is a central application hosted at the Commission's Data Centre (DIGIT/DC) and available over the Europa website:

http://ec.europa.eu/taxation_customs/tedb/taxSearch.html .

It also contains the Taxation Reform (TAXREF) system, which uses information provided by Member States together with the information in the TEDB databases to analyse the impact of tax reforms in the EU:

http://ec.europa.eu/taxation_customs/tedb/reformSearch.html

10.2.5.1.5. TECHNICAL DESCRIPTION

TEDBv2 is built on Weblogic and Oracle. It offers a web interface and the authentication functionality is provided by ECAS.⁵⁷

The Tax forms are filled in by the Member States and sent to DG TAXUD for verification and publication on the Europa site. The update can be triggered either by the Commission or by the Member States themselves. The application also offers a tax reforms tracking functionality.

⁵⁷ ECAS is the European Commission Authentication Service.

10.2.6. SUPPORT APPLICATIONS COMMON TO VAT, RECOVERY AND DIRECT TAX

All the Taxation TES are distributed systems in the Member States with no central node at Commission level. Each Member State is responsible for developing, maintaining and operating its own applications, in compliance with the rules agreed between the Member States and the Commission.

In order to operate Taxation TES, the Commission has developed, maintains and operates the following applications:

10.2.6.1. TEST APPLICATIONS

These applications evaluate the compliance of the Member States applications with the common system specifications. They are operated by the ITSM contractor of DG TAXUD for performing the conformance tests. The Self-Service Testing System (SSTS), a major new deployment, has recently improved the flexibility in the conformance test campaigns by increasing the ability of Member States to run Conformance Testing autonomously, with limited support from any other party. SSTS is grouped around a web portal, providing access to the different test modules, test data and management and reporting modules.

1) GENERIC TEST TOOL (GTT)

GTT is a modular test tool in production since 2006 that supports conformance testing for many taxation-related European Information Systems (VAT exchange of forms, VAT Refund, Recovery and Direct Taxation exchange of forms).

The GTT allows testing of XML-based information exchange. The central GTT tool takes care of all common functionalities such as CCN interaction, planning and reporting.

For each specific system a plug-in module is developed, that takes into account all elements that are specific to that information domain.

2) SELF SERVICE TESTING SYSTEM (SSTS)

SSTS is a central application in production since June 2012 hosted at the ITSM Data Centre (ITSM/DC). SSTS allows users to have an overview of all Testing Activities (to be performed, input (Test Data) and output (Reports and Logs) related to the below Components. Moreover, SSTS will allow the users to access and manage actually all Testing Activities related to these Components and will interface them directly. The SSTS allows the end-user to interact with the underlying test applications: the VIA / VTA and GTT (and associated plug-ins).

10.2.6.2. STATISTICS APPLICATIONS

Statistics applications compile monthly statistics on the exchanges for a given TES using the log files produced by CCN. It must be noted that for all the systems using CCN/Mail as transport layer, such statistics are produced by an application developed, maintained and operated by the CCN/TC contractor.

1) TAXATION STATISTICS SYSTEM (TSS)

TSS is a central application hosted at the ITSM Data Centre (ITSM/DC). It is a Web application that will allow the users to interact with the TSS and consult statistical reports. The TSS will support a set of predefined report as well as report customised on demand by the end user. The reports will be available through the application and available for download.

10.2.6.3. APPLICATIONS SUPPORTING EXCHANGE OF FORMS

1) EFORM EDITOR

A distributed application which allows working on several forms simultaneously and which manages global actions on forms. In production since 2008.

2) EFORM VIEWER

A distributed application which allows visualising the content of the e-forms related to VAT, Recovery of Claims and Mutual Assistance in the field of Direct Taxation without having to use the eForm editor

10.2.7. APPLICATION SUPPORTING INFORMATION EXCHANGE BETWEEN MS AND DG TAXUD

10.2.7.1. TAXATION INFORMATION AND COMMUNICATION (TIC)

TIC is a web-enabled interface allowing end-users to communicate useful information in the context of the cooperation between MSs and/or with DG TAXUD (e.g. VAT Refund MS preferences, invoicing rules). The objective of TIC is to ease the exchange of information between MS and DG TAXUD, in various contexts.

The TIC System is composed of two parts:

- The private part is accessible to Member State and DG TAXUD upon authentication;
- The public part is freely accessible via Internet.

The TIC is currently equipped with the following plug-ins:

- VAT Refund preferences: it allows the MS to communicate to their preferences for the VAT refund, system, such as defined in Directive 2008/9/EC
- Invoicing Rules: It allows DG TAXUD to collect from the Member States and publish the invoicing rules, in accordance to Article 32 of Regulation 904/2010
- Translation Modules: it allows for the collection from the Member States of some translatable items, such as the labels in Vies-on-the-Web or the e-Forms.

10.2.8. EXCISE TES AND APPLICATIONS

10.2.8.1. EMCS

10.2.8.1.1. LEGAL BASIS⁵⁸

- Decision No 1152/2003/EC⁵⁹ of the European Parliament and of the Council of 16 June 2003 on computerising the movement and surveillance of excisable products, which defined and launched the project;
- Council Directive 2008/118/EC of 16 December 2008 concerning the general arrangements for excise duty and repealing Directive 92/12/EEC;
- Commission Regulation (EC) No 684/2009⁶⁰ of 24 July 2009 implementing Council Directive 2008/118/EC as regards the computerised procedures for the movement of excise goods under suspension of excise duty;
- Council Regulation (EU) No. 389/2012⁶¹ of 2 May 2012 on administrative cooperation in the field of excise duties and repealing Regulation (EC) No 2073/2004.

10.2.8.1.2. BUSINESS DESCRIPTION

The Excise Movement and Control System (EMCS) is a computerised system for monitoring and controlling in real-time the movement of excise goods (alcohol, tobacco and energy products) for which duties still have to be paid. The project replaced the previous paper-based system based on the AAD (Administrative Accompanying Document) by an electronic system relying on a workflow of electronic messages between all parties involved (e-AD).

Under EMCS, a movement of excise goods between two traders is documented by means of the successive states of the electronic Administrative Document (e-AD), from issuance by the consignor to acknowledgement of receipt by the consignee. An e-AD is electronically submitted by the consignor and validated by the Member State of dispatch. In particular, the excise numbers of the consignor and the consignee are matched against a European register of operators (SEED). The e-AD is electronically transmitted to the Member State of destination, which forwards it to the consignee. An e-AD can be cancelled or updated under certain conditions. Upon reception of the goods, the consignee submits a "report of receipt", on which possible discrepancies including shortages or excesses are also mentioned.

Several other cases can arise; for instance, the consignee refuses delivery or the consignor splits the movement (for energy products only).

Development of EMCS started in 2002. The system entered fully into operations in 2011, after a roll-out period which started in April 2010. At present 27 national administrations of the EU Member States and thousands of excise traders – from small wine-growers to some of the major oil and tobacco multinationals – use EMCS to conduct their business. Since 1 January 2011, more than 6.7 million messages have been exchanged via the system.

⁵⁸ The legal basis covers the whole EMCS system including its supporting applications SEED, TA, CS/MISE and MVS.

⁵⁹ OJ L 162, 1.7.2003, p. 5

⁶⁰ OJ L 197, 29.7.2009, p. 24

⁶¹ OJ L 121, 8.5.2012, p. 1

As from 1 January 2012 EMCS covers also functionalities supporting administrative cooperation in the field of excise.

10.2.8.1.3. FUNCTIONAL DESCRIPTION

The main users of the system are economic operators and national administrations. The functionalities to be developed are explained in the Functional Excise System Specifications (FESS), mainly all the aspects of the electronic circuit of the e-AD, from its submission to its discharge, including the changes occurring during its journey.

10.2.8.1.4. APPLICATION DESCRIPTION

The Excise Movement and Control System (EMCS) is a distributed trans-European system composed of National Excise Applications (NEA) in the Member States of the EU exchanging XML messages over the Common Communication Network (CCN/CSI) operated by the Commission.

EMCS has been specified and developed according the common technical and functional specifications.

EMCS is comprised of a set of Applications.

- The Nationally Developed Excise Applications (NDEA), which are developed under the responsibility of and operated by Member States. The NDEA must adhere to the EMCS Systems specifications and in particular the TESS and the DDNEA especially regarding the interfaces with the common domain.
- The Centrally Developed Excise Applications (CDEA) providing EMCS services available in the Common Domain. They mainly encompass the crosscutting functions supporting the EMCS. The Central Excise Applications (CEA) are the CDEA which are operated by DG TAXUD. CDEA include SEED, an economic operators' registry, a Test Application (TA), to test the Members States' National Excise Applications, an application for the collection of statistics on the functioning of the system (CS/MISE) and e-Forms for verifying movements of excise goods under duty suspension (MVS).

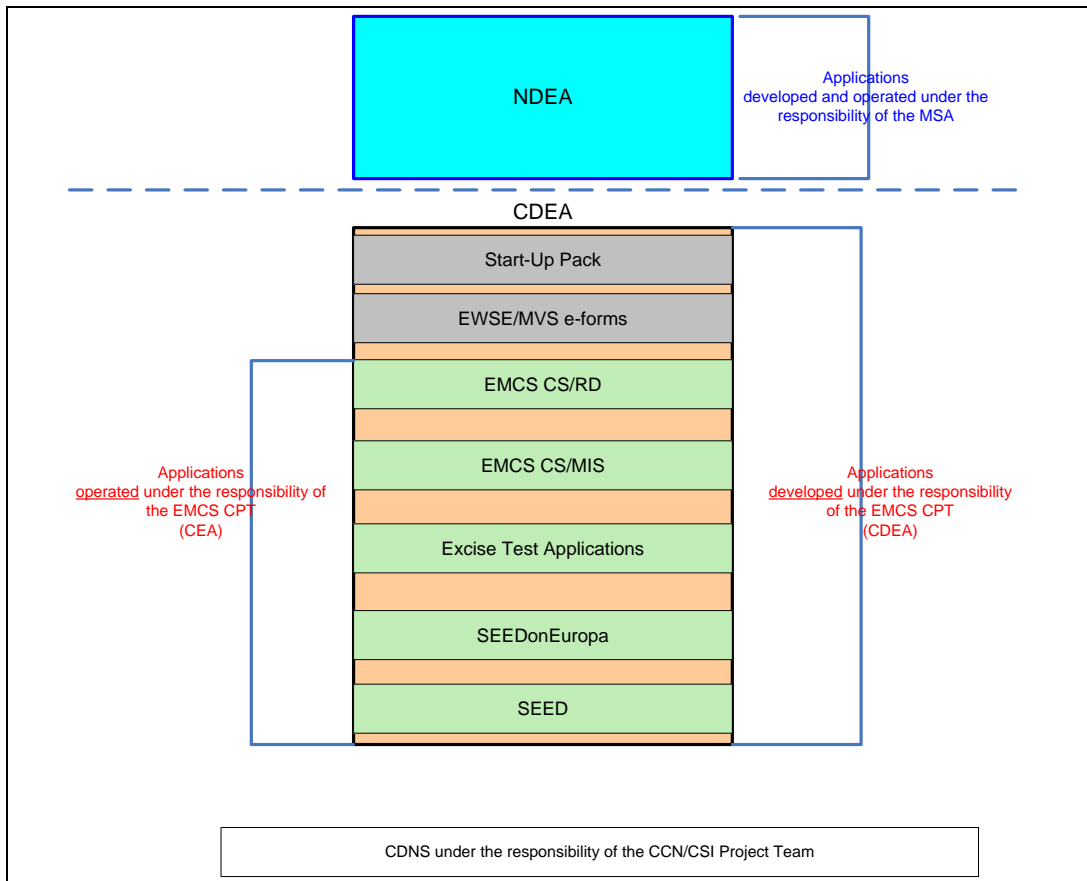

Figure 13: EMCS Applications Cartography

The following sections provide the main characteristics of all the applications in the EMCS system that will have to be taken over.

10.2.8.1.5. TECHNICAL DESCRIPTION

Each Member State administration has developed a national excise application (NDEA) on the basis of EMCS common specifications. NDEAs exchange information through CCN/CSI.

Below, additional information is provided on the EMCS supporting applications managed centrally by the Commission, the Centrally Developed Excise Applications (CDEA).

10.2.8.2. SYSTEM FOR EXCHANGE OF EXCISE DATA (SEEDV1)

10.2.8.2.1. BUSINESS DESCRIPTION

SEED is an obligatory electronic database located in each Member State and containing a register of persons who are authorized warehouse keepers or registered traders for excise duty purposes and a register of facilities approved as tax warehouses.

SEED is a system for Member State administrations to exchange registers of information concerning all economic operators, tax warehouses and temporary authorisations.

10.2.8.2.2. FUNCTIONAL DESCRIPTION

The System for Exchange of Excise Data (SEED) provides the following central services:

- Consolidation of the information sent by all countries in a central repository;
- Consultation of the SEED central repository via on-line web interface;
- Extraction of the content of the SEED repository on request;
- Automatic dissemination of the content of the SEED repository whenever the data from any of the Member States has been updated;
- The uploading the lists of all Excise Offices (EOL) in all Member States into the Customs Office List (COL) and consultation of excise offices information;
- Limited access to the SEED information for economic operators, in order to perform simple verification queries.

10.2.8.2.3. APPLICATION DESCRIPTION

The SEED platform consists of the central SEED and the national SEED Applications. The central SEED is located in the Common Domain and provides management and dissemination services regarding the registration information of Economic Operators and of EMCS reference data. The national SEED is located in the National Domain and enables the mirroring of the central SEED repository of economic operators and EMCS reference data at the national level.

10.2.8.2.4. TECHNICAL DESCRIPTION

SEED is the part of the whole EMCS system platform and consist of set of applications in Common and National Domains.

Its Common Domain, which is under the responsibility of the Commission, is composed of interconnected applications: Central SEED, NCTS CS/RD, DDS, EUROPA, CCN.

Its National Domain, under the responsibility of Member States administrations, is composed of national SEED applications, which serve as reference to NDEA (Nationally Developed Excise Application).

10.2.8.3. TEST APPLICATION (TA)

10.2.8.3.1. BUSINESS DESCRIPTION

In order to support testing activities on the NDEAs, and more specifically the Conformance Testing, the Commission developed a Test Application (TA). The TA is a central application,

installed at the Commission's Data Centre (DIGIT/DC), which communicates with the NDEAs via CCN/CSI. The TA receives/Sends messages from/to the NDEAs (National Development Excise Applications), in order to simulate real-world scenarios.

10.2.8.3.2. FUNCTIONAL DESCRIPTION

The TA can impersonate other Member States, allows for additional custom testing by Member States and allows for viewing/downloading reports of executed Test Scenarios.

10.2.8.3.3. APPLICATION DESCRIPTION

N/A

10.2.8.3.4. TECHNICAL DESCRIPTION

The figure below depicts the TA architecture:

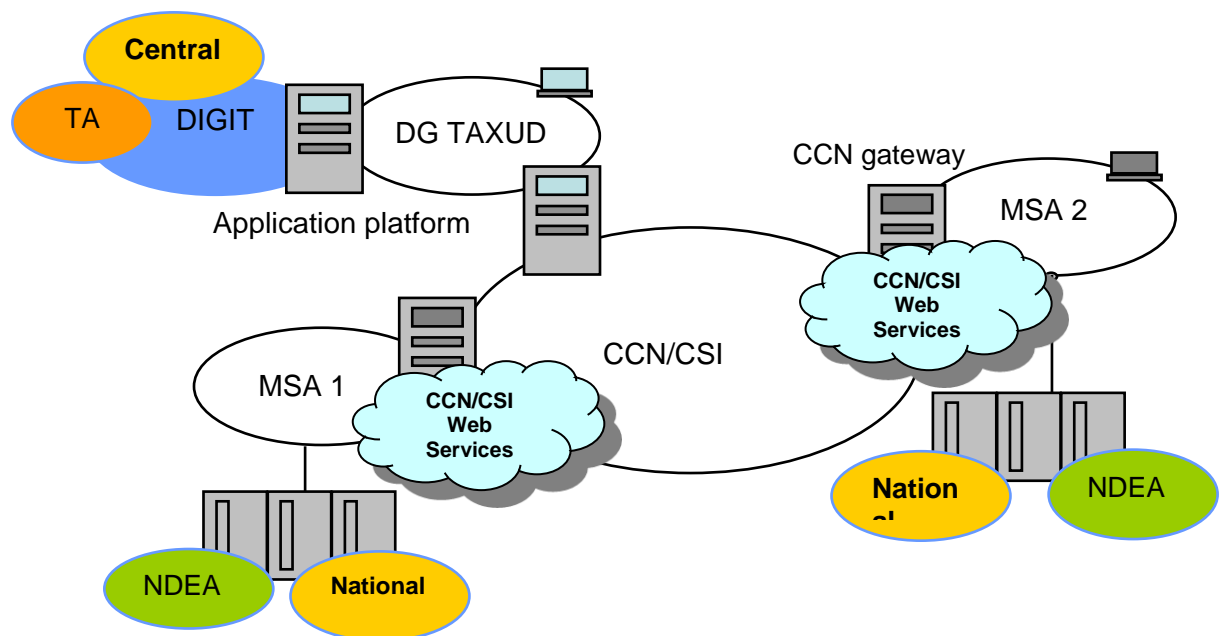

Figure 14: EMCS Test Application architecture

10.2.8.4. CS/MISE

10.2.8.4.1. BUSINESS DESCRIPTION

CS/MIS for EMCS (CS/MISE) business objective is to provide business statistics on the EMCS system as well as enabling the follow-up of the EMCS movements over the Common Domain.

10.2.8.4.2. FUNCTIONAL DESCRIPTION

CS/MIS for EMCS application allows:

- EMCS movements follow-up;
- Business statistics collection;

- Monitoring.
- Notification of unavailability of Member States' systems.

10.2.8.4.3. APPLICATION DESCRIPTION

The CS/MIS for EMCS is a central application using the CCN audit file information to achieve its functionality.

10.2.8.4.4. TECHNICAL DESCRIPTION

CS/MIS for EMCS is an application centrally hosted at the Data Centre of the ITSM contractor of DG TAXUD. It is a variant of CS/MIS for customs, based on industry standards.

10.2.8.5. MVS E-FORMS

10.2.8.5.1. BUSINESS DESCRIPTION

The Movement Verification System is one of the components of administrative assistance between Member States in the excise field. MVS allows the services responsible for monitoring movements to verify individual movements of goods between two traders. The central liaison office of a MS may request information from the central liaison office of another MS. For the purposes of this exchange of information a risk analysis, based on the e-AD, the AAD or SAAD information, must be carried out before a request is sent, and if it is considered necessary, after it is received. MVS is a standardised form.

10.2.8.5.2. FUNCTIONAL DESCRIPTION

Users of the application are the officials in the Member States competent for administrative cooperation in excise. Currently the MVS is realised under EMCS Phase 0, exchanging information via CCN mail. MVS Functional System Specifications are approved by the Committee on Excise Duty. As of 2012, under EMCS Phase 3, MVS exchanges related to movements under 'duty suspension' have been integrated in the EMCS and will be realised under the administrative cooperation thread as described in the Functional Excise System Specifications.

MVS will continue to support tracking of 'duty paid' movements until Phase 3.1 of EMCS.

10.2.8.5.3. APPLICATION DESCRIPTION

N/A

10.2.8.5.4. TECHNICAL DESCRIPTION

MVS consist in the exchange of electronic forms between Member States. The forms are exchanged through the CCN/Mail secure electronic messaging system.

MVS uses the following components:

1. Java based e-forms;
2. E-mail client with CCN/Mail access.

These exchanges of messages are implemented as the sending of e-mails containing XML attachments with the CCN/Mail system.

XML documents are exchanged between the CCN Gateway/ LCMS and the workstation in the form of attachments to e-mail messages.

XML documents are exchanged between the national MVS File Repository and the MS Officials workstations.

MVS e-forms are developed under the responsibility of the Commission but are operated by Member States.

10.2.8.6. MISCELLANEOUS EMCS APPLICATIONS

The current development contractor might have developed other minor EMCS applications which are not described in this Terms of Reference.

10.3. EVOLUTION OF TAXATION AND EXCISE TES AND NEW PROJECTS

10.3.1. EVOLUTION OF TAXATION TES AND APPLICATIONS

10.3.1.1. VAT RELATED SYSTEMS

VIES

The future evolution of VIES will focus on the implementation of the changes resulting from the Council Regulation (EU) No 904/2010.

These changes are centred on:

- the enrichment of VIES messages, by adding additional trader-related information (such as NACE⁶² activity codes and registration forms)
- the mandatory implementation of the 3rd Member States Request (3MS) messages, allowing Member States to request information from other administrations about transactions of their traders with 3rd Member States.

VIES-ON-THE-WEB

To improve the future experience of the users of the VIES-on-the-Web service, the following improvements of the system are currently underway:

- Improve the availability of the infrastructure: the Commission has improved its fail over arrangement by inter alia increasing its level of automation. It will as well further automate the administration of its infrastructure, minimizing its exposure to human errors. In the medium term (from 2014), the Commission takes steps in order to upgrade the availability of its infrastructure serving IT systems, including the central part of VIES-on-the-Web.
- Strengthen the reliability and robustness of the central application: an improved release 4 of the central part of VIES-on-the-Web will enter in production in early 2012 to increase the availability and responsiveness of the service. Testing procedures (including stress and performance testing) of the application were

⁶² http://epp.eurostat.ec.europa.eu/portal/page/portal/nace_rev2/introduction

strengthened. Furthermore from 2014 onwards the window during which application support is available will be extended to cover 7 days per week, 24 hours a day.

- Improve the information for the users: an information portal will be made available to users by early 2012, which will show the real-time operational status of both the Commission part and of the different national components.
- Improve the availability of Member State components: the VIES-on-the-Web service needs the Member States components to function. A Service Level Agreement (SLA) has been drafted, and according to the Council Regulation (EU) No 904/2010 and pending its approval at SCAC, the performances specified in this SLA will become part of the legal requirements from 2012 onwards.

EXCHANGE OF FORMS

Exchange of Forms work has started for three forms of exchange of information associated with Council Regulation (EU) No 904/2010 and Commission Implementation Regulation (EU) No 79/2012 on administrative cooperation in the field of value added tax. These forms entered into production in January 2008. For the automatic exchanges (Implementation Regulation 79/2012) forms, work is foreseen to start mid-2012 so as to have the eforms finalised by mid-2013.

As soon as the central application for exchange of forms is operational, the VAT, recovery and direct taxation forms will be migrated into it and the current Java forms will be phased-out.

It is not foreseen to migrate the VAT and / or Excise duty exemption certificate in XML as this form must be filled-in by economic operators, and not by tax administrations.

Member States have concerns with the forms in the MS-Excel format as this format does not allow to:

- preserve the integrity of the forms;
- fully or partially automate the processing of the forms;
- easily manage translation of the form labels into the EU official languages.

These forms will then be converted to XML as soon as they are considered enough stable.

VAT ON E-SERVICES (VOES)

VoeS was originally envisaged to be a temporary system. Yet, the current e-commerce scheme with provisions regarding broadcasting services and certain electronically supplied services from third countries has been extended indefinitely.

The implementation of the so-called "mini" One Stop Shop will lead to an extension of the VAT on e-services concept to include B2C EU operators supplying:

- e-Services;
- Radio and television broadcasting;
- Telecommunications.

These traders are currently registered in their Member States of establishment that provided them with a valid VAT number; the VAT obligation would be transferred to the Member State of Consumption.

This mini One-Stop-Shop (MOSS) will be functionally similar to the current VAT on e-services system.

10.3.1.2. RECOVERY

Work will start in 2013 on the specification of a system allowing Member States to inform each other, without prior request, where a refund of taxes or duties, other than value-added tax, relates to a person established or resident of that Member State.

As regards exchange of forms, as soon as the central application for exchange of forms is operational, the Recovery forms will be migrated into it and the current Java forms will be phased-out.

10.3.1.3. DIRECT TAX

TAXATION ON SAVINGS

Currently the exchanges are based on the FISC153 format, in production since 2008 exchanges. Member States requested that the initial exchanges be implemented over CCN/Mail2. The review of the Directive will lead to an updated FISC153v2 format⁶³.

The Commission may also propose to the Member States to implement the correction mechanism. The implementation of the correction mechanism will require the use of CCN/CSI instead of CCN/Mail2.

EXCHANGE OF FORMS

As regards the eforms, as soon as the central application for the eforms is ready, the Direct Tax forms will be migrated into it and the current Java forms will be phased-out.

10.3.1.4. OTHER TAX RELATED SYSTEMS

TAXES IN EUROPE DATABASE

The system may be subject to evolutive maintenance, on requests from the business unit. Search facilities may be added in order for the traders to find the relevant information more rapidly.

10.3.1.5. APPLICATIONS COMMON TO VAT, RECOVERY, DIRECT TAX

ELECTRONIC FORMS CENTRAL APPLICATION (EFCA)

In the first quarter of 2012, DG TAXUD completed a Feasibility Study to investigate the possibility of producing an Electronic Forms Central Application (eCFA). During the same period, work started on defining the Functional Specifications of the application.

eFCA is expected to enter in operation in 2014, supporting the exchange of information between Member States for VAT, recovery and direct taxation through a central portal.

DG TAXUD and the Member States expect that the eFCA will lead to significant improvements in maintenance and usability of the electronic forms.

⁶³ For additional information on the review of the EU Savings Directive please consult:
http://ec.europa.eu/taxation_customs/taxation/personal_tax/savings_tax/second_savings_directive_review/index_en.htm

10.3.2. EVOLUTION OF EXCISE SYSTEMS

EMCS will evolve as per the Master Plan approved by the Member States at the Committee on Excise Duties.

In 2013, the following activities are planned:

- Maintenance and evolution of EMCS specifications and supporting applications in preparation for Milestone "d" / Phase 3.1 of the project in November 2012;
- Conformance testing to ensure that the NDEAs are compliant with the common EMCS specifications; the Test Application and other centrally developed applications must be ready to support conformance testing one year before the milestone date of a new phase of EMCS;
- Phasing out of MVS e-Forms, currently used for administrative cooperation for duty paid movements;
- Enlargement of EMCS to Croatia;
- Production of business process models for the interface between EMCS and export and import control systems.
- Production of a feasibility study for the inclusion of duty paid movements in EMCS (currently the system covers movements under duty suspension).

It must be noted that the evolution of EMCS depends on legal / policy developments, and resources' availability at the Commission and in the Member States.

In addition, the evolution of the existing EMCS applications follows the overall IT strategy of DG TAXUD.

10.3.3. EU ENLARGEMENT

Interoperability and interconnectivity with EU taxation and excise systems is a requirement for candidate countries.

In the taxation area, assistance will be needed to facilitate the adaptation of the candidate countries' IT systems, to ensure successful interconnectivity with the existing and future DG TAXUD trans-European IT systems at the time of accession to the EU.

10.3.4. NEW PROJECTS

Important note: all projects described under this section are hypothetical as they are not part of a Commission proposal but only working hypothesis discussed in the Anti Tax Fraud Strategy Project group.

10.3.4.1. GENERAL REVERSE CHARGE

Both Austria and Germany submitted requests for a derogation under Article 27 of Council Directive 77/388/EEC to apply a generalised reverse charge mechanism. In addition, the UK had also asked for an Article 27 derogation, but only in respect of certain goods.

The requests from Austria and Germany attempt to use Article 27 for the purpose of making a fundamental change to the VAT system, and in doing so, eliminating one of its characteristics, which is the fractionated payment. The impetus behind these requests is the emphasis being put on tackling so-called “missing trader” fraud in the context of insufficient capability of Member States to control the businesses engaging in this type of fraud, which results in significant losses for Member States’ treasuries. Certain Member States are of the opinion that if a business is not permitted to charge VAT in the first instance, then the incentive to “go missing” disappears.

Hereafter, a description of the system proposed follows:

Customers receiving supplies under the reverse charge mechanism would have to dispose of a special VAT number, the validity of which would have to be confirmed by the supplier before making a reverse charge supply. This confirmation of validity would be done electronically and on-line. In addition, the suppliers would notify the tax authorities electronically each time that they make a reverse charge supply and declare the value of this supply.

The supplier would not charge VAT under the reverse charge system, but the purchaser would account for the VAT and deduct according to the normal rules. The customer would further have to declare separately in his return the reverse charge supplies received.

The tax administration would proceed to cross-check the information received electronically from the supplier with the information declared by the purchaser in order to prevent new fraud opportunities.

10.3.4.2. THE VAT GREEN PAPER

The Commission published on December 1st, 2010 a green paper proposing a package of measures to simplify the VAT system while making it more robust and efficient.⁶⁴ Most of the measure proposed are in relation with the complexity of the legislation and will have no impact on the VAT trans-European systems. However, sections 4 and 5.1 (re) introduce ideas that might have important impact on these systems:

- Implementing arrangements based on **taxation at origin**: the adoption of this principle will make the VIES network useless. On the other hand in its place a significant other central system of exchanging invoicing information would be needed to avoid the risk of new types of fraud. In parallel there would be a very

⁶⁴ This paragraph refers to the Green Paper the Commission published in preparation of its Communication on the Future of VAT of December 2011. For updated information on the state of play of the most recent Commission's proposals, please consult:

http://ec.europa.eu/taxation_customs/taxation/vat/future_vat/index_en.htm

sharp increase in the number of VAT Refund applications. The need for harmonisation of taxation rules would be very high, as would be the need for confidence in the effectiveness of other MS to collect the taxes due. On the positive side it could greatly reduce administrative burdens and improve the functioning of the internal market.

- The Council has ruled out this concept several times in the past and legislation recently adopted moved away from this principle. The probability to have it implemented in the medium-term is therefore quite low;
- Introduction of a one-stop-shop mechanism. Several proposals in the Green Paper would work efficiently only if a one-stop-shop mechanism is put in place. Those proposals are implementing changes to current arrangements based on **taxation at destination** and the scope of the related one-stop-shop could be extended gradually. It is the case for:
 - Taxation of intra-EU supplies of goods and services: this implies that the reverse charge mechanism currently in place for the intra-EU supplies is replaced by taxation in the Member States of establishment of the supplier. The VAT would be paid in the Member State where the purchaser is established but to the Member State of destination. The adoption of this principle will also make VIES useless in its current form, though MS at the supplier side will need a system to validate that payments were correctly made and MS at the consumer side need to be able to confirm that the right to deduct claimed by their consuming taxable persons were indeed covered by payments from the supplier.
 - Simplification, improved compliance and increase of cross-border trade: some B2C transactions are subject to VAT in a Member State other than that in which the supplier is established, which represents an obstacle for some businesses given who need to know the rules of all the other Member States. The implementation of a one-stop-shop mechanism can partly provide a solution for these businesses.
 - Reviewing the way VAT is collected. The paper proposes 4 models to review the way VAT is collected; each of these models or a combination of them is presented as a feasible way forward - and each model would have a significant impact on the current VIES system, mostly extending the scope of information to be exchanged and to whom the information must be made available.
 - According to a first approach banks would become responsible to transfer the required VAT to the correct MS at the time of money transfers for all intra-EU transactions. This would likely only be feasible with a significant central component for banks to validate information and taxation rules.
 - Via a central European VAT monitoring database where all invoices relative to intra-EU B2B transactions need to be sent in real time, allowing MS to immediately verify all transactions and payments.
 - Via similar but decentralised VAT data-warehouses maintained in real time by the taxable persons. This would have less need for a central system but is not very effective in reducing VAT fraud or administrative burdens
 - Via a certification process of taxable persons

10.3.4.3. FISCO

DG TAXUD is conducting, following consultation of Member States and of the OECD, a Feasibility Study on 'A Simplified Relief at Source System Implementing the Principles of the FISCO Recommendation'. This study is analysing a possible future EU-wide FISCO system, aimed at improving and simplifying procedures for tax relief cross-border investors. A project

group has been established for the FISCO project. The final report will be available in third quarter 2012.

It is worth noting that the OECD is working on a very similar system, called TRACE (Treaty Relief and Compliance Enhancement). The Trace IT Expert Group is a joint government/business group of IT experts created to address the technology issues relevant to ensuring that the information reporting and automatic exchange of information processes on the TRACE project can function effectively. During 2011, the TRACE IT Expert Group has conducted tests, identifying problems and developing solutions. A final report to the OECD will be produced in 2012.

Given the far-reaching similarities, a single consolidated approach for both potential systems is envisaged.

10.3.4.4. FINANCIAL TRANSACTION TAX (FTT)⁶⁵

The FTT is currently under discussion in the Council. It is too early to evaluate now the impact in terms of IT of the entry into force of such a tax. It is however not excluded that a trans-European system will have to be put in place to support possible exchanges between Member States.

10.3.4.5. US FOREIGN ACCOUNT TAX COMPLIANCE ACT (FATCA)

It is too early at this stage to determine how the recent evolution in FATCA could affect the existing TES in the field of taxation.

10.4. OPERATIONAL INFORMATION

The following gives some information about systems' operations.

10.4.1. TAXATION SYSTEMS

The following sections give statistical information about the number and size of messages exchanged by the different systems.

It must be borne in mind that regarding all systems using CCN/Mail2, no statistics on volume exchanged are available before 2006. Indeed, in May 2005, the former CCN/Mail system was replaced by CCN/Mail2. The original CCN/Mail system did not maintain statistical information on the size of the messages exchanged.

10.4.1.1. VAT RELATED SYSTEMS

10.4.1.1.1. VIES

Important note: VIES (including VIES-on-the-Web) is one of the Commission's flagship information systems in terms of operations allowing Member States to exchange more than 500 million messages in 2011, a number which is expected to exceed 1 billion by 2015.

The next table provides statistics about VIES exchanges between 2008 and Q1 2012.

⁶⁵ Proposal for a Council Directive on a common system of financial transaction tax and amending Directive 2008/7/EC

VIIES Messages	2008	2009	2010	2011	Q1 2012
Registry Requests	86,064,885	111,502,615	166,135,473	207,541,402	69,227,561
R_VATR	83,296,165	105,277,687	163,243,330	204,005,275	65,742,038
R_VATR_MATCH			16,773	29,850	2,510,745
R_HVATR	2,768,718	6,224,928	2,875,370	3,506,277	974,778
Turnover Requests	49,909,128	43,587,987	48,559,504	57,137,962	18,760,522
R_L1F1	35,979	42,112	47,112	57,360	18,368
R_L1C	46,726	64,489	78,645	86,758	19,578
R_L1CM	10,934	16,884	14,500	14,221	3,208
R_L1F2	23,992,598	17,609,590	20,442,728	23,378,413	8,412,234
R_L2F1	583,857	379,708	406,865	555,400	147,863
R_L1F2_3MS			21,263	35,403	9,893
R_L2F2	25,239,034	25,475,204	27,548,391	33,010,407	10,149,378
Registry Replies	77,783,746	103,243,302	150,806,362	178,848,443	60,242,834
D_VATR	75,094,704	97,066,229	147,987,981	175,547,695	57,626,350
D_VATD_MATCH	0	0	46	3	1,715,970
D_HVATR	2,689,042	6,177,073	2,818,335	3,300,745	900,514
Turnover Replies	6,848,860	6,869,329	7,140,749	11,410,803	4,368,526
F_L1F1	7,989	7,917	11,267	13,431	3,364
F_L1C	13,757	14,342	29,705	19,520	3,915
F_L1CM	16,167	20,412	13,439	14,501	2,867
D_L1F2	1,072,847	1,002,321	1,240,844	2,000,518	925,052
D_L2F1	146,580	149,619	153,914	216,203	68,227
D_L2F1_3MS			21,524	35,420	9,905
D_L2F2	5,591,520	5,674,718	5,670,056	9,111,210	3,355,196
F_L1QD	2,994	2,992	9,002	8,575	2,145
F_L1CS			3,625	8,347	2,020
O_MCTL	33,349	29,201	44,662	522,190	10,089
MS Warning	50,508,443	44,720,591	55,202,407	71,577,411	20,658,835
Total number of VIIES messages	271,151,403	309,956,017	427,901,784	527,055,133	173,272,532

Table 20: VIIES operation

10.4.1.1.2. VIIES-ON-THE-WEB

The WSDL file of the API is available at

http://ec.europa.eu/taxation_customs/vies/checkVatService.wsdl.

The traffic between 2008 and Q1 2012 is given in the next table.

	2008	2009	2010	2011	Q1 2012
Total VIIES/Web Validations	76,462,537	85,301,805	129,677,456	156,777,174	50,453,859
Interactive requests	41,530,685	41,054,233	63,955,720	75,389,345	21,103,960
Web service requests	34,931,852	44,247,572	65,721,736	81,387,829	29,349,899

Table 21: VIIES-on-the-Web operation

10.4.1.1.3. VAT EXCHANGE OF FORMS

The next tables indicate the traffic related to the SCAC forms and the recovery forms between 2008 and Q1 2012:

	2008	2009	2010	2011	Q1 2012
CCN/Mail2 exchanges					
SCAC Forms (exc. VoeS)	94,395	75,132	70,064	166,333	60,336
Direct Taxation Forms (exc ToS)	2,598	8,114	10,474	20,174	6,725
Recovery Forms	39,059	51,279	50,951	71,824	19,809

Table 22: Exchange of forms operation

10.4.1.1.4. VAT ON E-SERVICES

The addresses of the national Web sites are provided under http://ec.europa.eu/taxation_customs/taxation/vat/how_vat_works/e-services/article_1610_en.htm#19information.

The traffic between 2008 and Q1 2012 is given in the next table.

	2008	2009	2010	2011	Q1 2012
VAT on e-Services					
Number of messages	2,580	2,983	3,478	3,401	799

Table 23: VAT on e-Services operation

10.4.1.2. DIRECT TAXATION

10.4.1.2.1. TAXATION ON SAVINGS

The application was put into production in 2006. The traffic between 2008 and Q1 2012 is given in the next table.

	2008	2009	2010	2011	Q1 2012
Taxation on Savings					
Number of messages	2,354	2,372	2,146	2,582	112

Table 24: Taxation on Savings operation

10.4.1.3. TAXATION TES AND APPLICATIONS: SERVICE CALLS

As a further indicator of operational activity, the following table shows the ventilation of calls of the second and third level support that were open between March 2007 and May 2012. The ventilation is shown per priority, severity and category.

CI	# Issues
VIES Test Application	522
VAT Refund	369
VIES on-the-web	242
VIES	187
GTT VAT Refund	172
TEDBv2	171
No component	116
VIES Statistics System	83
Direct Tax Form	75
Recovery Form	59
SCAC e-Forms	54
SSTP	48
VIES Initial Application	42
VIES Monitoring	36
CT Test Tool - VIES	36
CT Test Tool - Reporting	34
GTT	33
CT Test Tool - VAT Refund	32
e-Forms	30
VIES on-the-web Monitoring	25
Taxes in Europe Database	18
VIES on-the-web Configuration Management	14
VIES VAT Algo	12
TIN on-the-Web	12
VIIES HTTP2CSIAdatper	9
VAT Refund Modules	6
VAT on e-Services	6
Taxation of Savings	5
General	3
Mini One Stop Shop	2
GTT EOF	2
Direct Tax Java e-Form Prototype	2
e-Form Viewer	1
Total*	2458

Table 25: Taxation Service Calls metrics - Calls per CI

Priority	# Issues
Minor	2296
Medium	1
Major	78
Trivial	28
Critical	5
Blocker	5
Total	2413

Table 26: Taxation Service Calls metrics - Calls per Priority

Category	# Issues
Blocking issues	5
Non blocking issues	2408
Total	2413

Table 27: Taxation Service Calls metrics - Calls per Category

10.4.2. EXCISE TES AND APPLICATIONS

The following sections give statistical information about the number of messages exchanged by the different EMCS supporting applications.

10.4.2.1. EMCS SUPPORTING APPLICATIONS

10.4.2.1.1. SEED OPERATIONAL STATUS

SEED has at least one new service pack every 6 months and one maintenance release a year; both developed by development contractor.

Table below represents different SEED releases in 2011:

SEED release	Delivery date
SEED v1.6.0	05/2011
SEED v1.6.1	07/2011
SEED v1.6.2	09/2011

Table 28: SEED deliveries

10.4.2.1.2. SEED-ON-EUROPA WEB PAGE HITS STATISTICS

The table below provides the number of hits on the SEED-on-Europa web page for the period from November 2011 to April 2012:

Month	Number of hits
2011-11	533651
2011-12	606610
2012-01	732427
2012-02	568117
2012-03	614544
2012-04	616188

Table 29: SEED-on-Europa web page hits

10.4.2.1.3. TEST APPLICATION

Test Application (TA) for EMCS is developed by the development contractor. In general at least one new service pack of TA delivered every 6 months. Table below represents TA releases for 2011:

TA release	Delivery date
------------	---------------

TA v2.1.0	02/2011
TA v2.2.0	06/2011
TA v2.2.1	07/2011
TA v2.3.0	10/2011
TA v2.3.1	11/2011

Table 30: TA deliveries

To support Member States during the period of EMCS Conformance testing a dedicated Rapid release plan for TA is maintained. On average two releases per month are planned during the Conformance testing period; table below represents Rapid release plan for TA in 2011:

TA Rapid Releases	Delivery date
TA Release #1	23/09/2011
TA Release #2	11/10/2011
TA Release #3	25/10/2011
TA Release #4	08/11/2011
TA Release #5	21/11/2011
TA Release #6	05/12/2011

Table 31: TA rapid releases

10.4.2.1.4. CS/MISE

CS/MISE has at least one new service pack every 6 months and one maintenance release a year; both developed by development contractor; table below represents releases for CS/MISE in 2011:

CS/MISE release	Delivery date
CS/MISE v1.0.3	01/2011
CS/MISE v2.0.0	06/2011
CS/MISE v2.1.0	11/2011

Table 32: CS/MISE releases

10.4.2.1.5. MVS E-FORMS

Figure below represents the MVS Statistics for all Member States for the period 2009-2011:

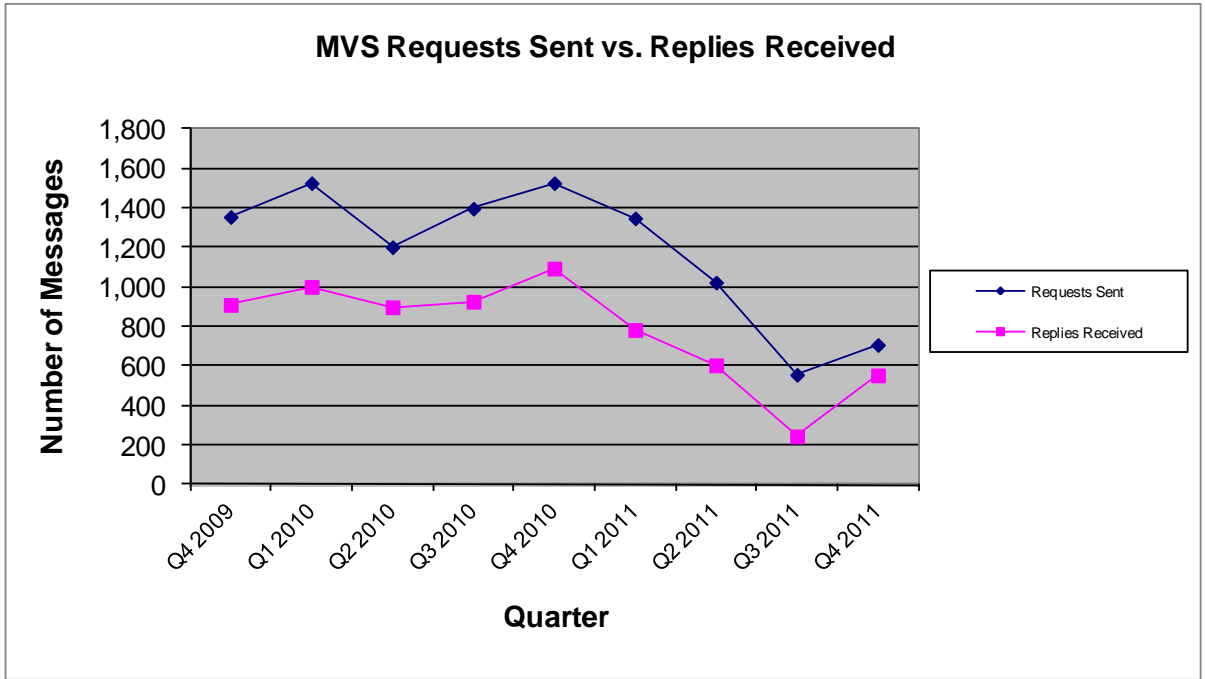

Figure 15: MVS Requests sent vs. replies received

Currently there are no maintenance releases foreseen for MVS e-forms as they will be phased out in 2013.

10.4.2.2. EXCISE TES AND APPLICATIONS: SERVICE CALLS

EMCS Service Calls per month (for all Member States) covering EMCS and EMCS related systems (SEED, TA, CS/MISE and the MVS e-forms) are presented in the figure below:

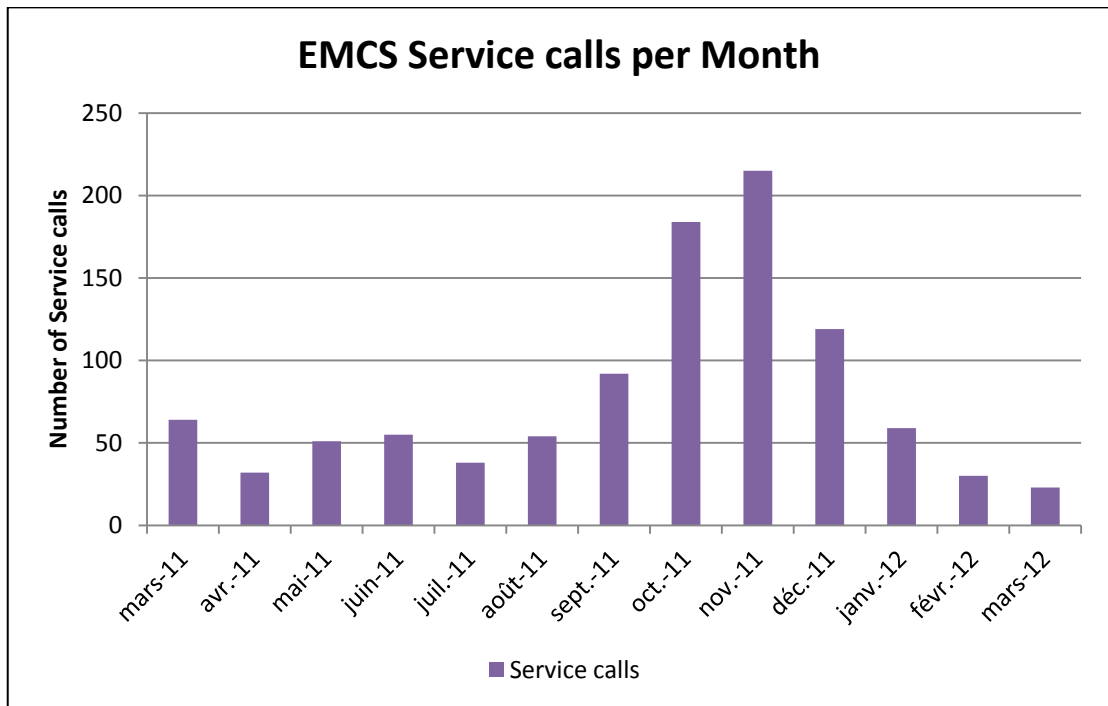

Figure 16: EMCS Service calls per Month

It is interesting to note on the figure above the correlation between the Service calls and the EMCS milestones (Milestone Mc on 01/01/2012). There is a high increase of Service calls during the Conformance Testing period prior to entering into production at Milestone Mc.

The table below shows the ventilation of calls of the second and third level support that were open between March 2011 and March 2012. The ventilation is shown per priority, category and issuer. 90% of the Service Calls originate from the Member States and about 65% are handled by the Specifications Team.

The Service Desk is currently operated by the ITSM contractor.

Ventilation of the Service calls open between 01/03/2011 - 29/03/2012	
Call per Priority	
Minor (Low & Medium)	473
Major (High)	543
Call per Category	
Specifications Team	659
TA Development Team	189
SEED Development Team	134
CS/MISE Development Team	32
EMCS Converter	2
Call per Issuer	
Member States	921
ITSM	88
DG TAXUD	5
CCN/TC	2
Total	1016

Table 33: EMCS Service calls metrics

10.4.3. EVOLUTION OF OPERATION BY THE HORIZON 2020

10.4.3.1. TAXATION TES AND APPLICATIONS

The following figures show the foreseen evolution of the traffic until 2020 for all taxation systems, i.e. CSI and CCN/Mail2 traffic included. The estimation of number and volume of messages for the whole EU is based on the available data today.

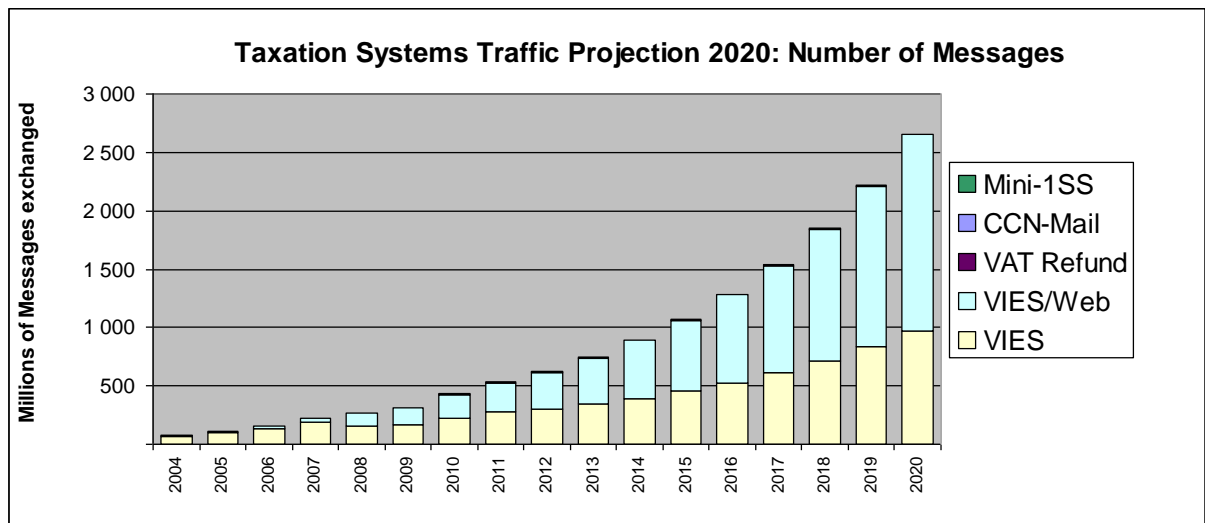

Figure 17: Taxation Traffic evolution horizon 2020 – Number of Messages – Min-1SS refers to the VAT Mini One Stop Shop

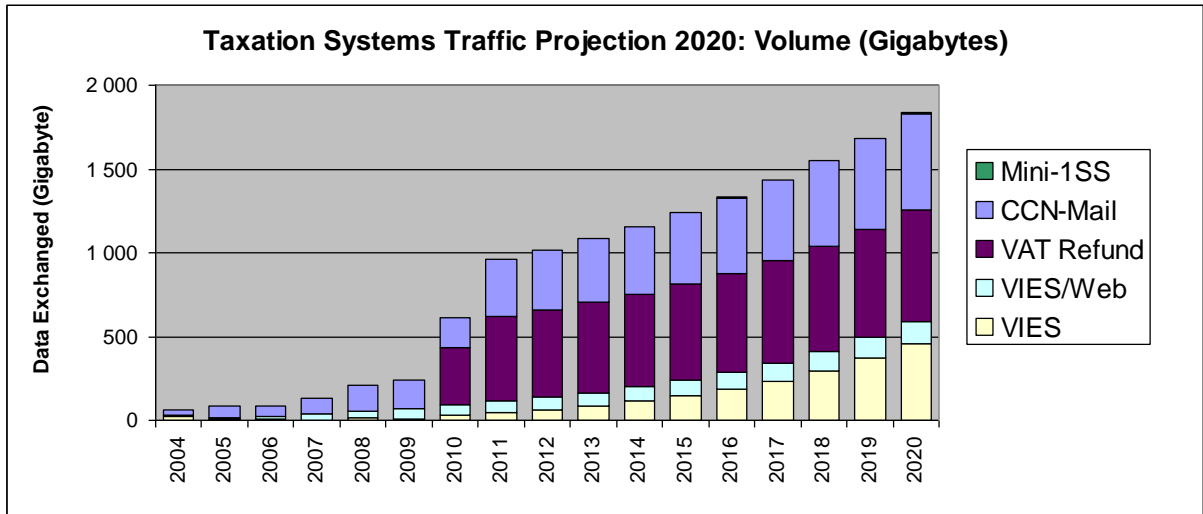

Figure 18: Taxation Traffic evolution horizon 2020 – Volume in Gigabytes

10.4.3.2. EXCISE TES AND APPLICATIONS

The following figures show the foreseen evolution of the traffic by the horizon 2020 for the EMCS system. The estimation of number and volume of messages for the whole EU is based on the only available data today.

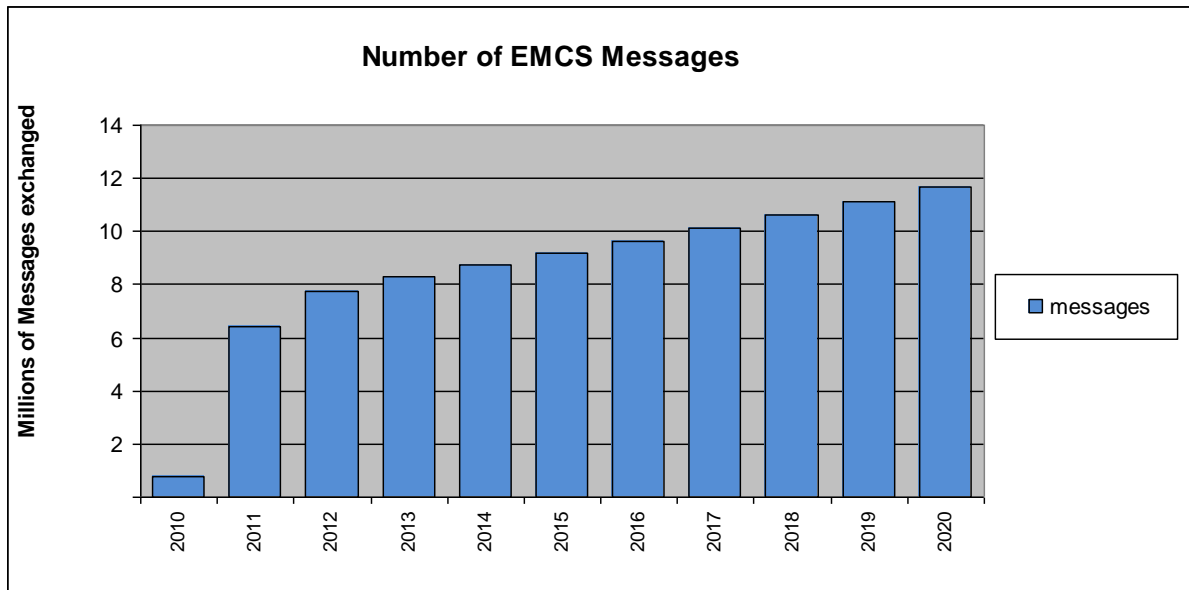

Figure 19: EMCS traffic evolution by 2020 – Number of messages

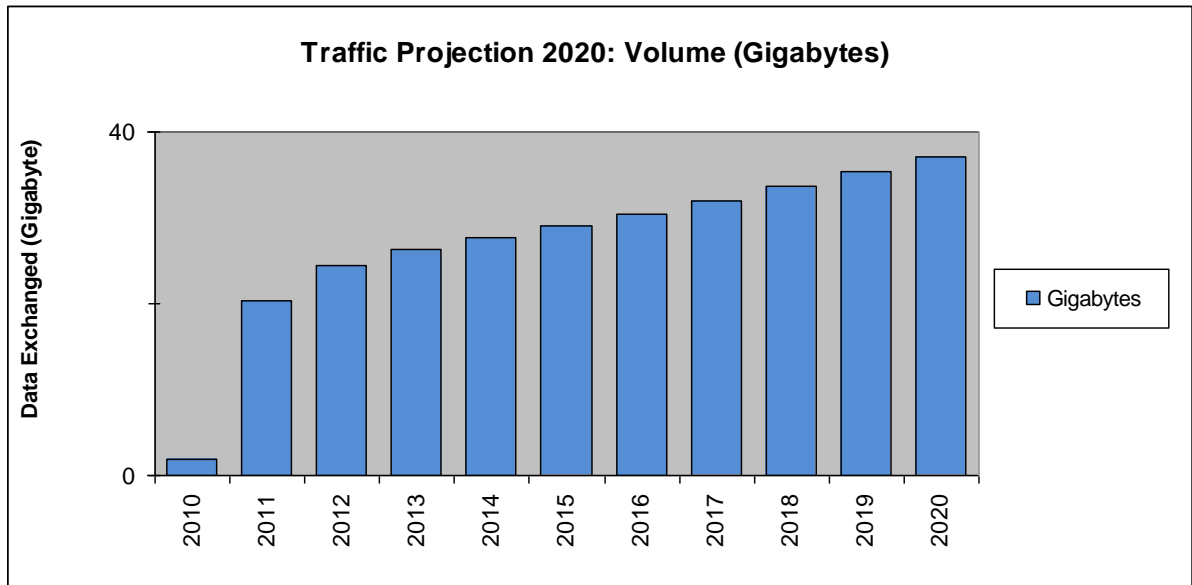

Figure 20: EMCS traffic evolution by 2020 – Volume in Gigabytes

11. CCN NETWORK

Important note: the information provided below is an extract from the CCN2 call for tender terms of reference.⁶⁶ It aims at giving the tenderers a full, clear and precise description of the CCN network.

11.1. OVERVIEW OF THE CCN NETWORK

The Common Communications Network / Common Systems Interface (CCN/CSI) is a value-added network operated by the Directorate-General for Taxation and Customs Union (DG TAXUD). The mission of CCN today and in the future is to provide common services to exchange taxation, excise and customs information at reasonable cost, with high agility, high security and continuity. CCN was designed between 1993 and 1995 and is operational since 1999. Today, the CCN/CSI relies on:

- The Common Communications Network (CCN), which is composed of a series of physical Gateways located either in the National Administration or on the Commission premises. These Gateways are interconnected in a secure way through communications services and locally connected to the application platforms provided by the local site.
- The Common Systems Interface (CSI), which is a set of protocols and application programming interfaces allowing the above-described application platforms to exchange information through the CCN backbone. It ensures the interoperability between the relevant heterogeneous systems in the National Administration.

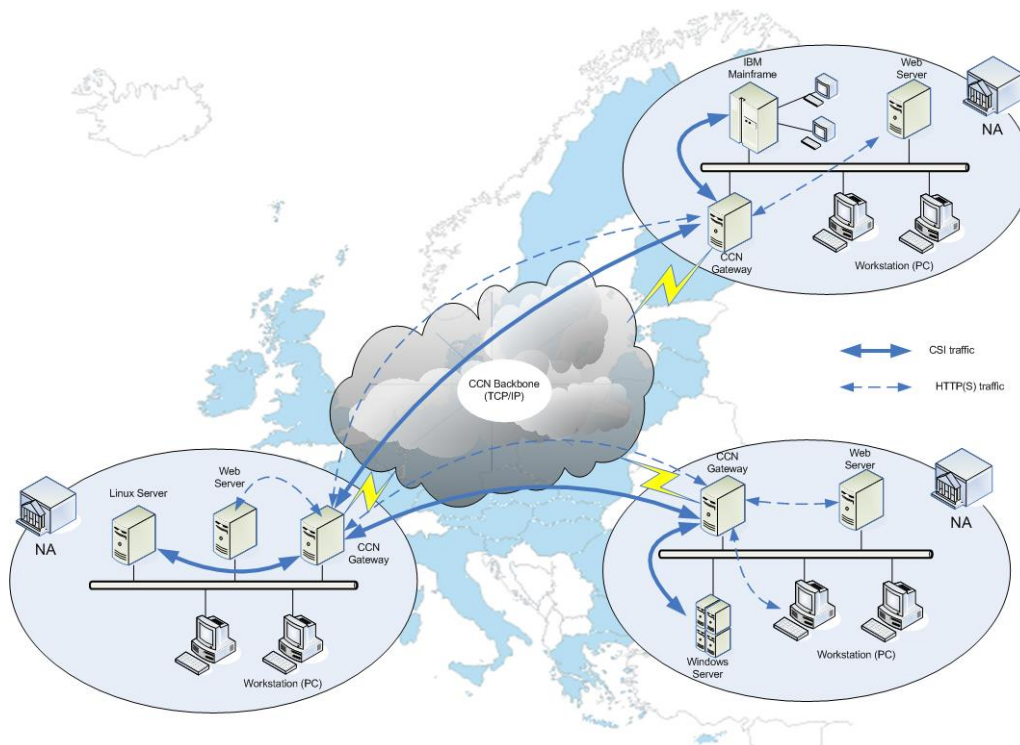

Figure 21: CCN/CSI topology overview

CCN is the largest e-communications platform among customs and taxation administrations worldwide, and delivers a variety of specific services to support various policies⁶⁷. CCN and

⁶⁶ See http://ec.europa.eu/taxation_customs/common/tenders_grants/tenders/index_en.htm.

CSI are managed and developed by the Directorate General for Taxation and Customs Union (DG TAXUD) in conjunction with the Member-State administrations concerned.

CCN/CSI serves all of the EU Members States and the EFTA members Norway and Switzerland. It also extends to third countries, including Russia for example, via a separate system named SPEED. The provision of services may extend to Candidate Countries such as Turkey, and the former Yugoslav Republic of Macedonia (FYROM), and to other countries according to the evolution of the taxation and customs policies. Such countries may also include Moldova, Ukraine, Belarus, China, United States, Japan and India. OLAF relies on the CCN infrastructure to carry out anti-fraud campaigns in collaboration with the EU Member States.

The CCN/CSI provides a network which is:

- Secure:
 - CCN/CSI runs on a dedicated private hardware infrastructure;
 - All data transmitted over the network is encrypted;
 - Access to the network is controlled by strong user authentication and authorisation.
- Accessible:
 - The network has access points (CCN Gateways) in every Taxation and Customs administration;
 - The CSI software ensures that heterogeneous computer systems can access the network.
- Reliable:
 - Data exchanges over the network have guarantees of delivery ;
 - All hardware and software elements of the network are constantly monitored.

The CCN/CSI infrastructure can be split into 2 domains:

- The "European" domain infrastructure is owned by DG TAXUD and operated by the service providers. Inside this domain, the CCN backbone and access equipment are provided by the network provider. The operation supplier remains the sole responsible for the operation of CCN/CSI infrastructure deployed in each National Administration or at DG TAXUD premises.
- The "national" or "local" domain components which are under the full responsibility of the National Administrations.

Of over 50 central applications and 18 distributed systems relying on CCN/CSI, the most critical are VIES (VAT Information Exchange System), NCTS (New Computerised Transit System), EMCS (Excise Movement and Control System), ICS (Import Control System) and AFIS (Anti-Fraud Information System). These applications range over the collection of taxes and duties, the security of trade, the control of fraud and illicit trade, VAT information and more.

In addition to the CCN sites installed in National Administrations, there are also sites located centrally. These are located in the European Commission Data Centre, and in the

⁶⁷ Customs, Excise, Taxation, Anti-fraud, Fisheries, and Agriculture related.

European Anti-Fraud Office (OLAF) and provide CCN access to centralised information systems. The remaining sites are located at the CCN Technical Centre (CCN/TC) and ITSM Data Centre. Finally it is important to mention that there is a project ongoing with the objective to consolidate all DC.

The subsequent sections are describing the functionalities provided by CCN/CSI, its components and the overall architecture.

11.2. OBJECTIVES OF THE CCN/CSI MIDDLEWARE

The general objectives of the CCN/CSI middleware can be summarised as follows:

- To offer to all National Administrations a coherent method of access to all DG TAXUD applications;
- To offer all National Administrations a coherent method of access to other National Administration applications;
- To provide a high level of service on an equal basis to all National Administrations;
- To allow for the integration of other Commission entities hence extending the coherence of access to non-DG TAXUD applications;
- To provide a solution that is not dedicated to a particular application (or even several applications) but rather a general purpose solution which will be valid for a long period of time;
- To ensure the interconnectivity between the CCN/CSI sites;
- To ensure the interoperability in a heterogeneous environment;
- To ensure the continuity of the services.

The technical objectives are:

- To provide a robust and standardised backbone;
- The backbone provides to the applications synchronous and asynchronous CSI services, web services and mail facilities in an integrated manner;
- To have a high quality administration system so as to offer a high quality of service. This robust administration of the European domain adheres to the subsidiary principle, allowing the National Administrations to benefit from a local administration for their national domain;
- To provide a consistent API on the Application Platforms of all the National Administrations;
- To provide widely accepted API.

In order to achieve these objectives, the CCN/CSI middleware must:

- Continue to consolidate the solid organisation and to deliver continuous, efficient and reliable services to customs, taxation and excise users by providing a harmonised and secure method of having access to and exchanging information between the communities of users (National Administration and the European Commission). In the near future, this may require an increase in the guaranteed continuity of service of the network to 24 hours/day, 365 days/year;
- Cope with an increasing number of users, sites and applications relying on the CCN/CSI middleware and guarantee a smooth implementation of new application's requirements;
- Anticipate the expansion of the CCN/CSI to new Candidate Countries, to third countries and handle the increase in service demand;

- Align the CCN/CSI with technical evolutions in the marketplace;
- Validate the CCN/CSI strategy, architecture trends and draft guidelines taking into account existing applications;
- Limit the financial impact of the expansion of the CCN infrastructure as a whole and be responsive to cost evolutions in the marketplace;
- Support extended protocols and standards.

CCN/CSI will continue to evolve, both in terms of the information systems that it supports and the value-added services that it provides. The levels of security and availability will be maintained. As more demand is made to CCN/CSI middleware, hardware upgrades will be made in order to maintain performance. CCN/CSI will also continue to expand, both in terms of the countries which are connected (Candidate Countries and other EU economic partners) and the administration domains that use it.

11.3. SERVICES OFFERED TO THE APPLICATIONS OF THE NAS

The CCN/CSI middleware services allow the development of applications using synchronous, asynchronous, web or e-mail interactions on the different hosts of the National Administrations.

The services offered can be summarised as follows:

- Synchronous service: an application can invoke another application in a request/response mode; with the restriction that CCN/CSI does not offer distributed transaction support;

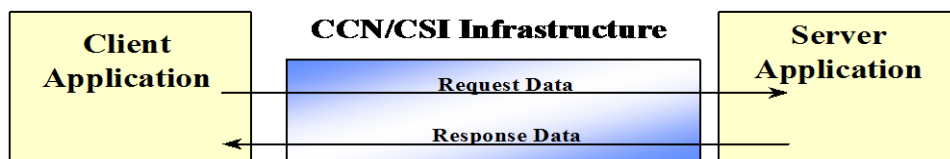

Figure 22: CCN/CSI synchronous service

- Asynchronous service: an application can exchange messages with other applications in an asynchronous manner (store and forward technique). In this case, the applications see each other via message queues;



Figure 23: CCN/CSI asynchronous service

- HTTP traffic: an application can exchange messages with other applications in a synchronous way using the HTTP protocol;

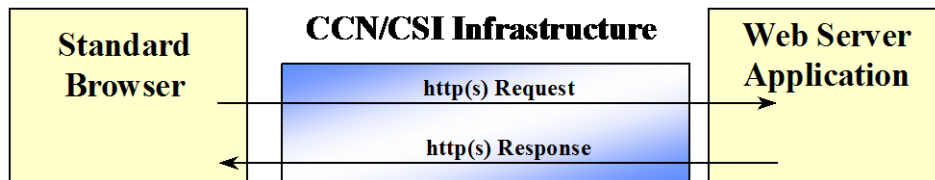

Figure 24: CCN/CSI HTTP traffic

This enables Internet browsers to access web servers located on centralised servers via the private CCN network – and not via the Internet. The first information systems which are examples of this technology, the Specimen Management System (SMS), the Information System for Processing Procedures (ISPP) and the European Binding Tariff Information system (EBTI) are already in operation. Also already in operation is the CCN/TC Web Portal – an information source for CCN users;

- Mail service: a user (or an application) can exchange mail messages with other users (or applications) in an asynchronous way using the SMTP protocol. In addition to standard messages, this system, CCN Mail3, also supports the exchange of forms between National Administrations, directory services and could possibly be used for value-added services such as workflow management.
- Interoperability: National Administrations applications run on different Application Platforms, each one with its own data format. The infrastructure handles all the necessary conversions on behalf of applications (restricted to very limited set of character encoding), which deal only with their own native format;
- The exchanges between National Administrations Application Platforms are secured. Two levels of security are provided:
 - At the European level (security devices are present between each CCN/CSI Gateway and the CCN/CSI Backbone, so that the CCN/CSI Gateways are in a DMZ);
 - At the CCN/CSI access point (links between the Application Platforms and the Gateways) where authentication, confidentiality and integrity mechanisms are provided.

11.4. SECURITY

The security of CCN/CSI is organised according to the underlying IDA architecture, in particular to the Euro Domain and Local Domain principles. So, there are two kinds of security responsibility domains:

The European security domain includes only systematic, non-negotiable services: mutual authentication of Gateways, access control lists (user / user profile / resource) recorded on the Gateways and a hardware-based encryption of all trans-European communications.

The National security domains include an authentication of the user and application to the Gateway in two possible contexts:

- Secure links, meaning well protected, communication lines from an application platform having its own security subsystem may be considered as secure enough to have a direct access to the gateway.
- In other cases, the link is said to be non-secure, and additional authentication features such as three-way authentication are offered.

The Security Service covers three functions: authentication, confidentiality and integrity. It is part of the Function Layer.

On National Domain, the GSS_API is used to call the security services and to compute security tokens. For confidentiality and integrity, data are sealed and unsealed (in the

GSS_API terminology, “sealing/unsealing” means sealing/unsealing and enciphering/deciphering). For the authentication, the Security Service relies on CSI_API to transfer the security context.

On European Domain, the Security Service relies on the Gateway cryptographic devices plugged on the CCN Backbone.

11.5. ADMINISTRATION

The Administration Software of the CCN/CSI Gateway provides a set of tools allowing the administrators to configure and manage the CCN Gateway software. It provides the administration functions covering the following functional areas:

- Configuration and Name Management, which allows the administrators to manage the configuration and naming of the various software products and components of the CCN Gateway;
- Fault Management, which provides error detection and reporting mechanisms to facilitate troubleshooting;
- Accounting and Performance Management, which provides functions to collect statistics information for further analysis by external applications (e.g. generation of reports regarding CCN service availability, message transit delay, backbone usage, Gateway management);
- Security Management, which provides functions to the administrators to configure and manage security information, such as user authentication keys, user profiles and Access Control Lists (ACL). Security management also provides security logging mechanism;
- Control and Monitoring, which allows the administrators to control and monitor the operation of the CCN Gateway software. Control and monitoring functions include start-up, stop and restart of the CCN Gateway software, and supervision of the running CCN/CSI software processes to detect possible unexpected fallen processes.

Most of the common configuration information is stored in the CCN Directory, which allows the Administration Software to provide auto-configuration facilities, to make use of the replication mechanism provided by the CCN Directory to synchronise configuration information and to simplify configuration management.

The Administration Software provides the technical means to allow the administrators of the Member States to locally perform administration, configuration and management of the CCN Gateway software. It provides also facilities to allow the Central Administrator from the CCN Technical Centre to perform centralised remote administration.

11.6. CCN/CSI SUBSYSTEMS

The applications communicate with each other through the Inter Application Bus (IAB). The accesses to the Quality of Service (QoS) management are carried out by the IAB. The IAB constitutes the CCN/CSI middleware. It is split into several subsystems as presented in the figure below.

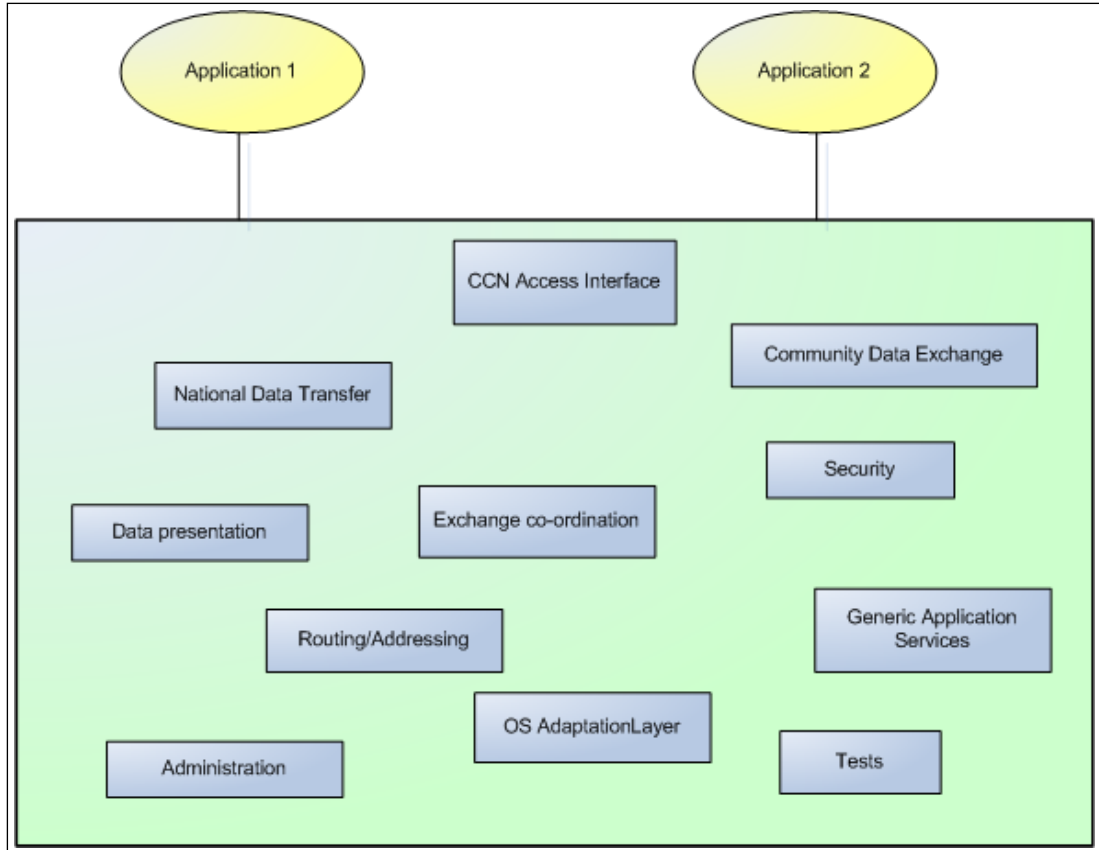

Figure 25: CCN/CSI Functional Subsystems

The Functional Subsystems composing the CCN/CSI middleware are as follows:

- **CCN Access Interfaces:** this subsystem is the entry point offered to the applications in order to access and to use the CCN/CSI middleware. This subsystem is the access point for all information entering or leaving the CCN/CSI middleware. It is distributed on the Application Platform and the CCN/CSI Gateway. It includes the HL_API, the CSI_API, the JCSI_API and the NJCSI_API and the Function layer. The SPI_API is included in this subsystem as an internal entry point in the gateway though it cannot be used by the applications. Concerning the HTTP interactions, the API provided to the National Administrations relies directly on specific handlers run by the HTTP server. For mail exchanges, the CCN Access Interfaces are in fact SMTP, IMAP and POP3⁶⁸.
- **National Data Transfer:** this subsystem provides the transfer means used to exchange information between the Application platforms and the related CCN/CSI gateway. It is distributed on the Application Platform and the CCN/CSI Gateway. It includes the T_API, the GT layer, the CT_API and the CT layer.

⁶⁸ Concerning the SMTP, IMAP and POP3 protocols, a webmail interface is also offered for convenient purpose.

- **For HTTP and mail exchanges**, TCP/IP takes the transfer between the Application Platforms and the CCN backbone in charge.
- **Community Data Exchange**: this subsystem is responsible for the data transfer between two CCN/CSI gateways. It includes the Function layer in the European Domain described in the next "Functional Architecture Model" paragraph. The Function and Transmission Layer role is to convey the CCN/CSI messages. The Communication layer of the European Domain is based on the following underlying products: Tuxedo, MQSeries (accessed through the GT_API), Apache (HTTP protocol) and MS-Exchange (SMTP/IMAP/POP3/Webmail protocol).
- **Exchange Co-ordination**: this subsystem allows the scheduling of the services offered by other subsystems (Data Presentation, Security, and Routing/Addressing) in order to ensure their activation in a consistent way. It takes charge of the Quality of Service (QoS) required by the Applications. This subsystem is a mandatory access point for all information to be handled within the system.
- **Security**: this subsystem provides the security services, including access control, authentication, integrity and confidentiality. It provides the GSS_API to the Applications in order to access to the security services. It is distributed on the Application Platform and on the CCN/CSI Gateway.
- For HTTP exchanges it makes use of SSL, especially during the authentication phase.
- **Generic Application Services (GAS)**: this subsystem includes all the CCN/CSI services running directly on the CCN gateways.
 - For synchronous and asynchronous services, these applications are relying on the same API as applications running on Applications Platforms. The only difference is located in the authentication mechanism, which is replaced by an identification mechanism.
 - For web services, these applications are implemented via a specific content-handler integrated in the Apache HTTP server running on the gateway.
- **Routing/Addressing**: this subsystem is responsible for the routing/addressing resolution of the messages sent by the applications to their destination. Its goal is to associate a resource logical name to a final destination, assuring the coherence regarding the mode of the partners and the gateways they are running on.
- **Data Presentation**: this subsystem provides the means to convert the data exchanged between heterogeneous application platforms, to and from a common format used by the IAB.
- **Administration**: this subsystem allows the administration of the subsystems that make the CCN/CSI middleware.
- **Tests**: this subsystem provides the means to perform application environment tests with the CCN/CSI middleware.
- **OS (Operating System) Adaptation Layer**: this subsystem provides, for portability purpose, services to the Application Platforms subsystems permitting to mask the dependencies of system dependent operations.

11.7. THE FUTURE OF THE CCN NETWORK

In order to cope with the new IT systems and the expected growth of the traffic, the common private communication network (CCN) will need to be upgraded as well. This concerns not only its capacity but also its security and its overall architecture.

The CCN network will evolve as described in the CCN2 Terms of Reference.⁶⁹

⁶⁹ See http://ec.europa.eu/taxation_customs/common/tenders_grants/tenders/index_en.htm.